

ORO

2024

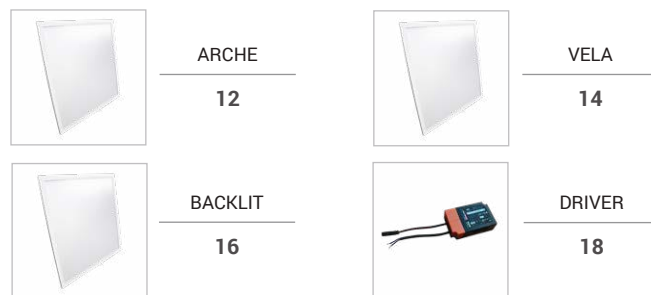

Panele LED / LED panel / Panele LED / LED panel



Lampy liniowe LED / Led linear lamps / Liniová svítidla LED / Lineárne svietidlá LED



Downlight LED / LED downlight / LED downlight / Downlight LED



Led spotlight / Spotlight LED / Zapuštěné bodové led svítidla / Zapuštěné bodové led svietidlá

Plafony LED / LED ceiling lamps / Nástěnná a stropní led svítidla / Nástenné a stropné led svietidlá



Oprawy hermetyczne LED / Hermetic LED luminaires / Prachotěsná LED svítidla / Prachotesné LED svietidlá



Oprawy hermetyczne / Hermetic luminaires / Prachotěsná svítidla / Prachotesné svietidlá



Oprawy liniowe / Linear luminaires / Liniová svítidla / Lineárne svietidlá



High-bay LED / LED high-bay / LED svítidla high-bay / LED svietidlá high-bay



Naświetlacze LED / LED floodlights / LED reflektory / LED reflektory

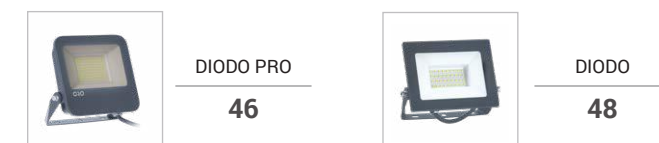

Oprawy kanałowe LED / LED bulkhead / Kanálová svítidla / Kanálové svietidlá

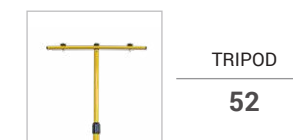

Lampy architektoniczne / Architectural lamps / Fasádní a zahradní lampy / Fasádne a záhradné lampy





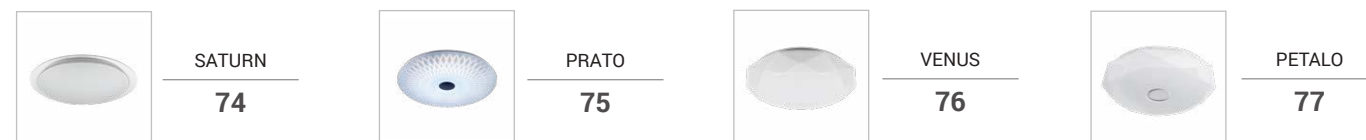



Plafony / Ceiling lamps / Nástěnná a stropní svítidla / Nástenné a stropné svietidlá



Oprawy sufitowe / Ceiling lamps / Stropní svítidla / Stropné svietidlá



Reflektorki LED / Spotlight LED / Zapařtěně bodově led světidla / Zapuřteně bodově led světidla

	AQUILA 80		BRANTA 82		STERNA 84		GAVIA 86
	FALCO 88		TRINGA 90				

Lampki biurkowe / Desk lamps / Stolně lampiĉky / Stolně lampy

	EPSILON 92		PICA 94		LETTA 96		ADRI 98
	ANTILA 100		VERO 102		LARUS 104		

Lampy elewacyjne i ogrodowe / Facade and garden lamps / Fasědně i zahrědně lampy / Fasědně a zahrědně lampy

	ALBA 106		ZOE 108		CUBE 109		SAN 109
	SPARK 110						

Tařmy LED / LED strips / LED pěsky / LED pěsy

	LCOB 152		WI-FI SET 154		CCT SET 155		RGBW SET 156
	14W/m 157		10W/m 158		8W/m 159		14W/m 50m 160
	8W/m 50m 161		CRI / WW-CW 162		RGB 164		COLOR 165

Sterowniki i wzmacniacze / Drivers and amplifiers / Ovladaĉe a zesilovaĉe / Budiĉe a zosilňovaĉe

	CONTROLLER 166		CONTROLLER 167
---	--------------------------	---	--------------------------





Profile i akcesoria / Profiles and accessories / Liřty + pŕisluřenstvě / Profily pre led pěsy + pŕisluřenstvo

	PROFIL SET 168		PROFIL 171		COVER / CAP 172		CONECT 174
--	--------------------------	--	----------------------	--	---------------------------	--	----------------------

03

ŹRŔDĚĽA ŐWIATĽA / LIGHT SOURCES / SVĚTELNĚ ZDROJE / SVETELNĚ ZDROJE

ŹarŔwki LED / LED light sources / LED světla / LED lampy

	E27 114		E14 121		E27 FILAMENT 128		E14 FILAMENT 132
	GU10 134		MR 16 142		MR 11 143		G9 G4 144

Tuby LED / LED tubes / LED trubice / LED trubice

	GLASS POWER 148		GLASS 150		BASIC 151
--	---------------------------	---	---------------------	---	---------------------

04

OSPRŹĘT ELEKTROINSTALACYJNY / ELECTRICAL INSTALLATION EQUIPMENT
ELEKTROINSTALAĀNĬ ZARĬŹENĬ / ELEKTROINŐTALAĀNĚ ZARIADENIA

Czujniki ruchu / Motion sensors / ŀidlo pohybu / Sněmaĉe pohybu

	PIR 178		MIC 179
---	-------------------	---	-------------------

Zasilacze / Supplies / Elektronickě napějecě zdroje / Elektronickě napějacě zdroje

	MEANWELL POWER SUPPLY 180		EMERGENCY 181		12V DRIVER 182		ADAPTER 183
	ACCESSORIES 184						

Produkty ORO od Led-Pol są poddawane rygorystycznym testom w laboratorium oświetleniowym, co zapewnia ich zgodność z obowiązującymi normami, bezpieczeństwo użytkowania oraz spełnienie najwyższych standardów jakości.

ORO products by Led-Pol undergo rigorous testing in a lighting laboratory, ensuring compliance with current standards, safe usage, and adherence to the highest quality standards.

Produkty ORO od Led-Pol jsou podrobeny přísným testům v laboratoři osvětlení, což zajišťuje jejich soulad s platnými normami, bezpečnost používání a dodržování nejvyšších kvalitativních standardů.

Produkty ORO od Led-Pol sú podrobené prísnym testom v laboratóriu, čo zabezpečuje ich súlad s platnými normami, bezpečnosť používania a dodržiavanie najvyšších kvalitatívnych štandardov.

PURE QUALITY EU LAB CONFIRMED



www.lablumen.com

lablumen
photometric laboratory & EMC

All lighting tests:

Light distribution curves / Luminous Flux test
/EMC Electromagnetic Compatibility /
Photobiological risk test / Flicker test / And others

01

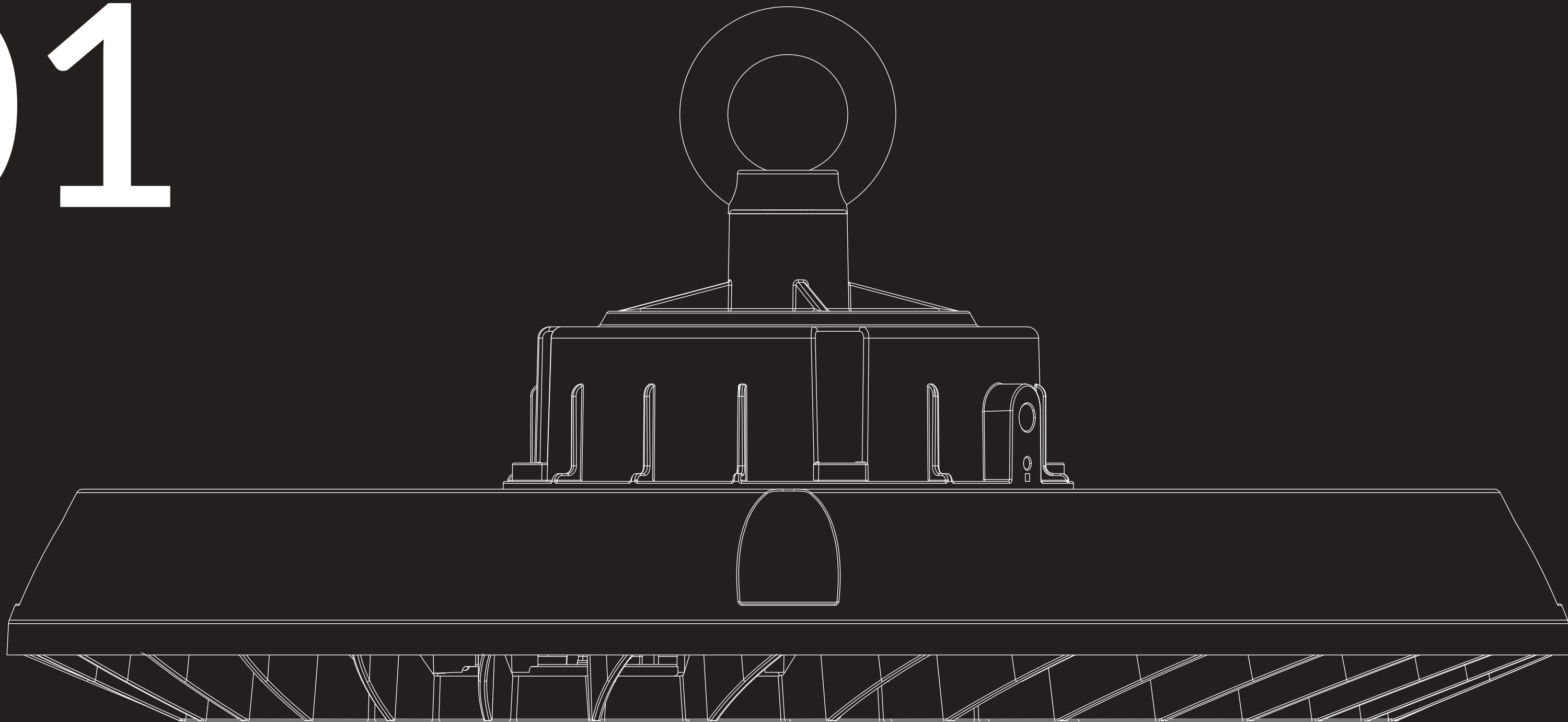

TECHNICAL LIGHTING

OŚWIETLENIE TECHNICZNE / TECHNICKÉ OSVĚTLENÍ /
TECHNICKÉ OSVETLENIE

ARCHE

5

years
warranty

ALU PS

PMMA



Index	Name	EAN	Pon [W]	Φmod [lm]	Φ360° [lm]	η [lm/W]	CCT [K]	L x W x H [mm]		
ORO07039	ORO-PANEL-ARCHE-60X60-40W-DW-XP	5902533195251	40	5600	4600	115	4000	595 x 595 x 9		1,94
ORO07040	ORO-PANEL-ARCHE-60X60-60W-DW-XP	5902533195268	60	8400	6900	115	4000	595 x 595 x 9		1,97
ORO07041	ORO-PANEL-ARCHE-30X120-40W-DW-XP	5902533195275	40	5600	4600	115	4000	1195 x 295 x 9		2,0

Panel	40W DRIVER	60W DRIVER
	ORO15093	ORO15094
	ORO15095, ORO15062	ORO15096

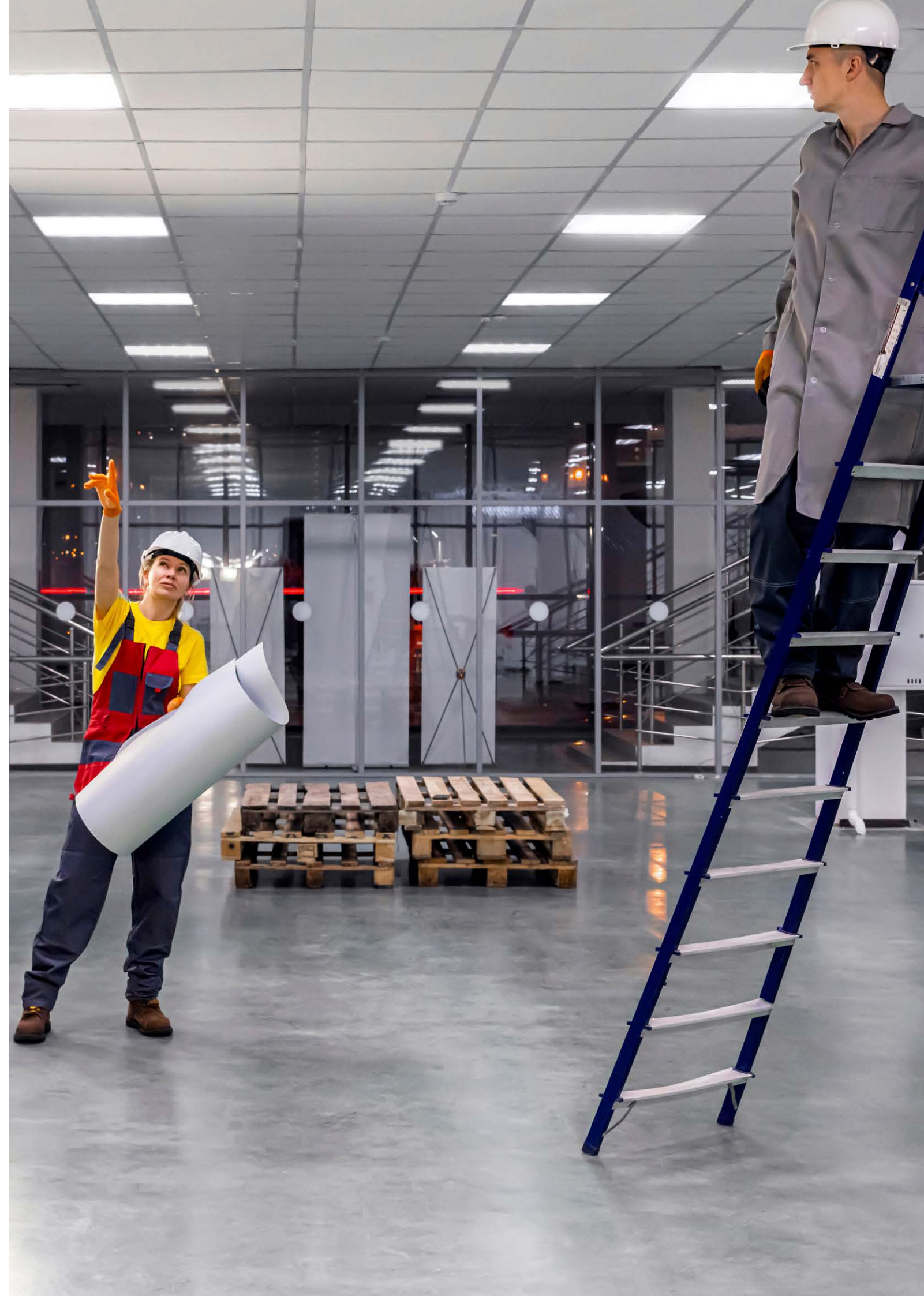
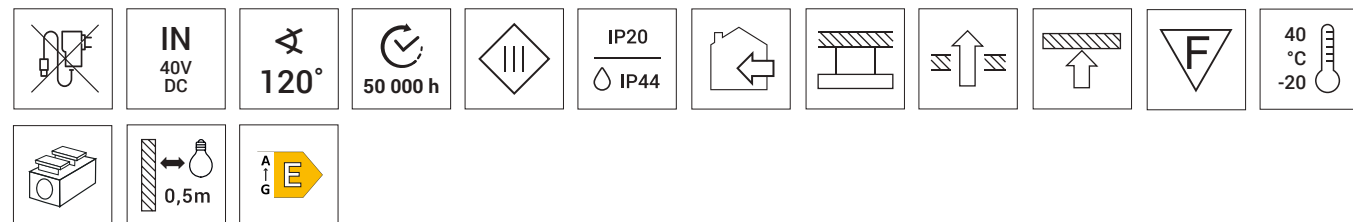

VELA

3
years
warranty



Index	Name	EAN	Pon [W]	Φmod [lm]	Φ360° [lm]	η [lm/W]	CCT [K]	L x W x H [mm]		
ORO07044	ORO-PANEL-LED-VELA-60X60-40W-DW-III	5902533199044	40	5200	4000	100	4000	595 x 595 x 9		1,86
ORO07045	ORO-PANEL-LED-VELA-60X60-40W-CW-III	5902533199051	40	5200	4000	100	6500	595 x 595 x 9		1,86
ORO07047	ORO-PANEL-LED-VELA-60X60-60W-DW-III	5902533199075	60	7800	6000	100	4000	595 x 595 x 9		1,90
ORO07048	ORO-PANEL-LED-VELA-60X60-60W-CW-III	5902533199082	60	7800	6000	100	6500	595 x 595 x 9		1,90
ORO07049	ORO-PANEL-LED-VELA-30X120-40W-DW-III	5902533199099	40	5200	4000	100	4000	1195 x 295 x 9		1,97

Panel	40W DRIVER	60W DRIVER
	ORO15093	ORO15094
	ORO15095, ORO15062	ORO15096



VELA UGR

3
years
warranty

UGR
<19

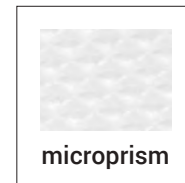

Index	Name	EAN	Pon [W]	Φmod [lm]	Φ360° [lm]	η [lm/W]	CCT [K]	L x W x H [mm]		
ORO07053	ORO-PANEL-LED-VELA-60X60-40W-DW-UGR	5902533199808	40	5200	3800	95	4000	595 x 595 x 9		1,93
ORO07054	ORO-PANEL-LED-VELA-60X60-60W-DW-UGR	5902533199815	60	7800	5800	97	4000	595 x 595 x 9		1,96
ORO07055	ORO-PANEL-LED-VELA-30X120-40W-DW-UGR	5902533199822	40	5200	3800	95	4000	1195 x 295 x 9		1,97

Panel	40W DRIVER	60W DRIVER
	ORO15093	ORO15094
	ORO15095, ORO15062	ORO15096

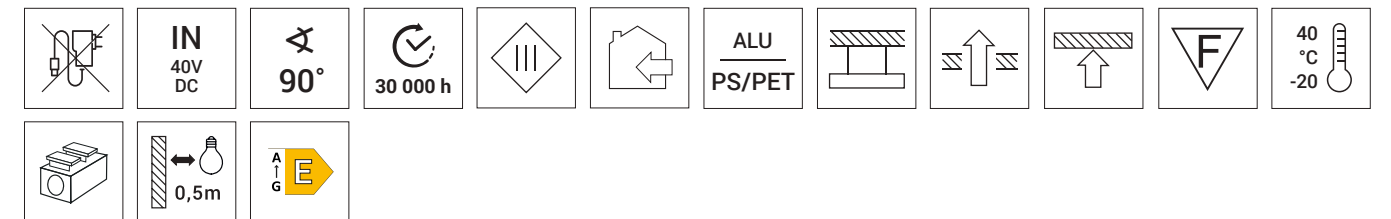

BACKLIT



5**
years warranty

WW NW CW
CCT

UGR <19

PF >0,95**

+



Index	Name	EAN	Pon [W]	Φ360° [lm]	Φuse [lm]	η [lm/W]	CCT [K]	L x W x H [mm]		
ORO07056	BACKLIT LED 36W 60X60 NW *	5902533199952	36	4000	-	111	4000	595 x 595 x 27	<input type="checkbox"/>	1,38
ORO07057	BACKLIT LED 36W 30X120 NW *	5902533199969	36	4000	-	111	4000	1195 x 295 x 32	<input type="checkbox"/>	1,44
ORO07058	BACKLIT LED 60W 60X60 NW *	5902533199976	60	6600	-	110	4000	595 x 595 x 27	<input type="checkbox"/>	1,55
ORO33118	ORO BACKLIT LED 36W 60X60 NW UGR **	5901752716315	36	4140	3600 $\leq 120^\circ$	115	4000	595 x 595 x 27	<input type="checkbox"/>	1,65
ORO33119	ORO BACKLIT LED 36W 30X120 NW UGR **	5901752716414	36	4140	3600 $\leq 120^\circ$	115	4000	1195 x 295 x 32	<input type="checkbox"/>	1,73
ORO33116	ORO BACKLIT LED 36W 60X60 CCT **	5901752716384	36	4140	-	115	3000-4000-6500	595 x 595 x 27	<input type="checkbox"/>	1,3
ORO33117	ORO BACKLIT LED 36W 30X120 CCT **	5901752716445	36	4140	-	115	3000-4000-6500	1195 x 295 x 32	<input type="checkbox"/>	1,4

Index	Name	EAN	
ORO07003	LINKA-PANEL60X60	5901752714281	Linka montażowa / Mounting rope / Montážní lano / Montážne lano
ORO07013	ORO-CLIPS-PANEL60X60-U	5902533191369	Zacpek podtynkowy / Concealed hook / Skrytý háček / Skrytý háčik
ORO07019	RAMA-PANEL60X60-UC	5902533192922	Ramka natynkowa do panelu 60x60cm / Surface-mounted frame for a 60x60cm panel / Přisazený rám pro panel 60x60cm / Prísadený rám pre panel 60x60cm
ORO07020	RAMA-PANEL30X120-UC	5902533192939	Ramka natynkowa do panelu 30x120cm / Surface-mounted frame for a 30x120cm panel / Přisazený rám pro panel 30x120cm / Prísadený rám pre panel 30x120cm
ORO33161	RAMA-PANEL60X60-UC-H	5905972140073	Ramka natynkowa do panelu 60x60cm - wysoka / Surface-mounted frame for a 60x60cm panel - high / Přisazený rám pro panel 60x60cm - vysoký / Prísadený rám pre panel 60x60cm - vysoká

3*
years warranty

IN
220-240V
50Hz

110°

20 000 h

50 000 h

CRI > 80

ALU
PS

0,5m

AIG E

DRIVER



Index	Name	EAN	Description
OR015093	ORO-DRIVER-PANEL-40W	5902533199723	Zasilacz 40W / Power supply 40W / 40W napájecí zdroj / 40W zdroj
OR015095	ORO-DRIVER-PANEL-40W-0-10V	5902533199747	Zasilacz ściemniający 40W 0-10V / Dimmable power supply 40W 0-10V / Stmievateľný zdroj 40W 0-10V / Stmievateľný zdroj 40W 0-10V
OR015062	ORO-DRIVER-DIMM-40W-DALI	5902533193363	Zasilacz ściemniający 40W DALI / Dimmable power supply 40W DALI / Stmievateľný zdroj 40W DALI / Stmievateľný zdroj 40W DALI
OR015094	ORO-DRIVER-PANEL-60W	5902533199730	Zasilacz 60W / Power supply 60W / 60W napájecí zdroj / 60W zdroj
OR015096	ORO-DRIVER-PANEL-60W-0-10V	5902533199754	Zasilacz ściemniający 60W 0-10V / Dimmable power supply 60W 0-10V / Stmievateľný zdroj 60W 0-10V / Stmievateľný zdroj 60W 0-10V



RAGGIO

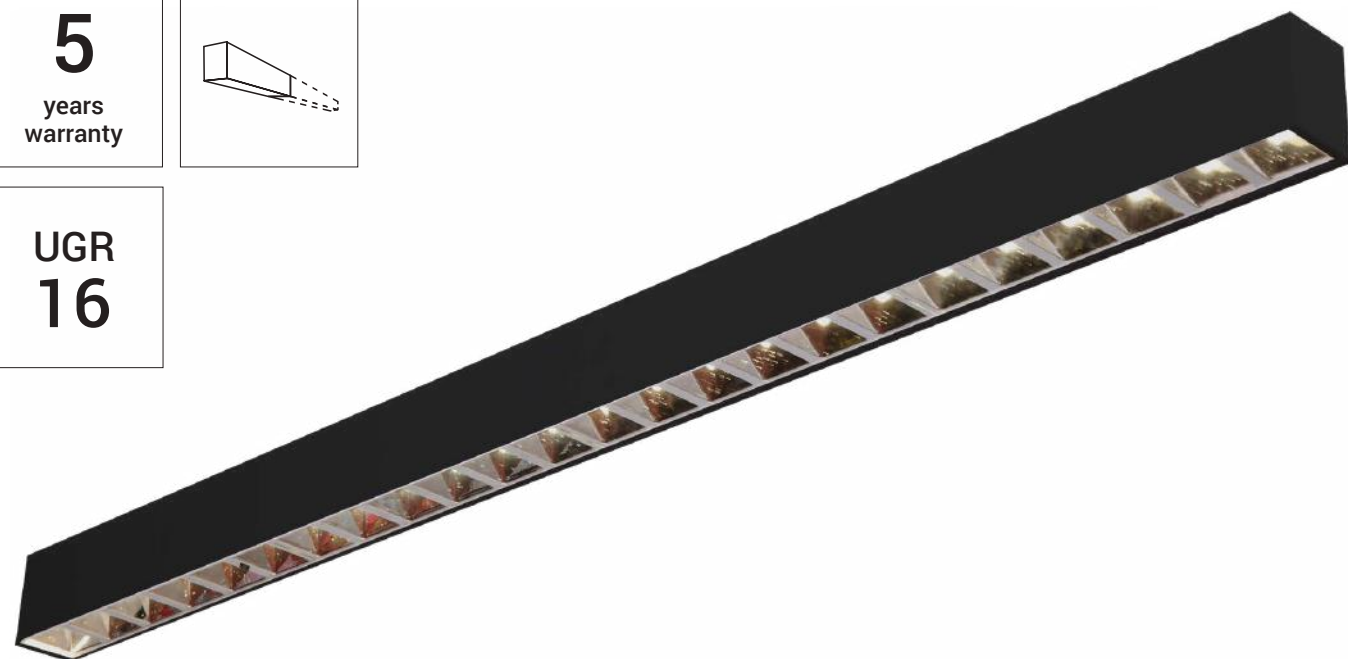
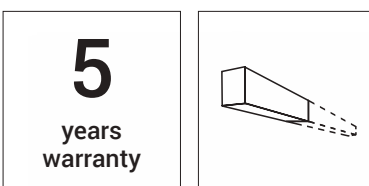

Index	Name	EAN	Pon [W]	Φ360° [lm]	Φuse [lm]	η [lm/W]	CCT [K]	L x W x H [mm]		
ORO18037	ORO-RAGGIO-WHITE-40W-DW-L	5902533196159	40	5200	5000 α 90°	130	4000	1200 x 70 x 50		1,78
ORO18038	ORO-RAGGIO-SILVER-40W-DW-L	5902533196166	40	5200	5000 α 90°	130	4000	1200 x 70 x 50		1,78
ORO18039	ORO-RAGGIO-BLACK-40W-DW-L	5902533196173	40	5200	5000 α 90°	130	4000	1200 x 70 x 50		1,78

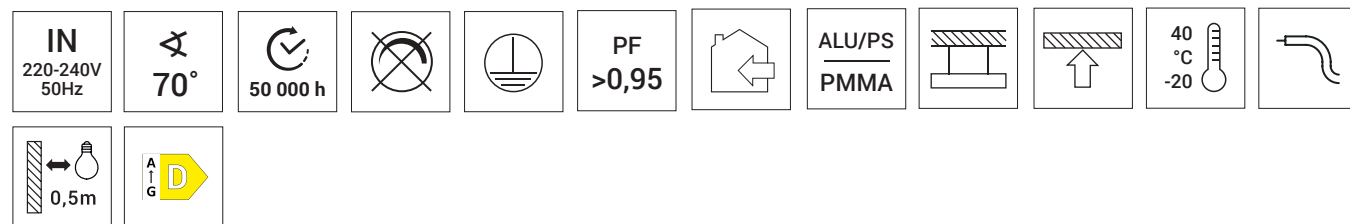

+

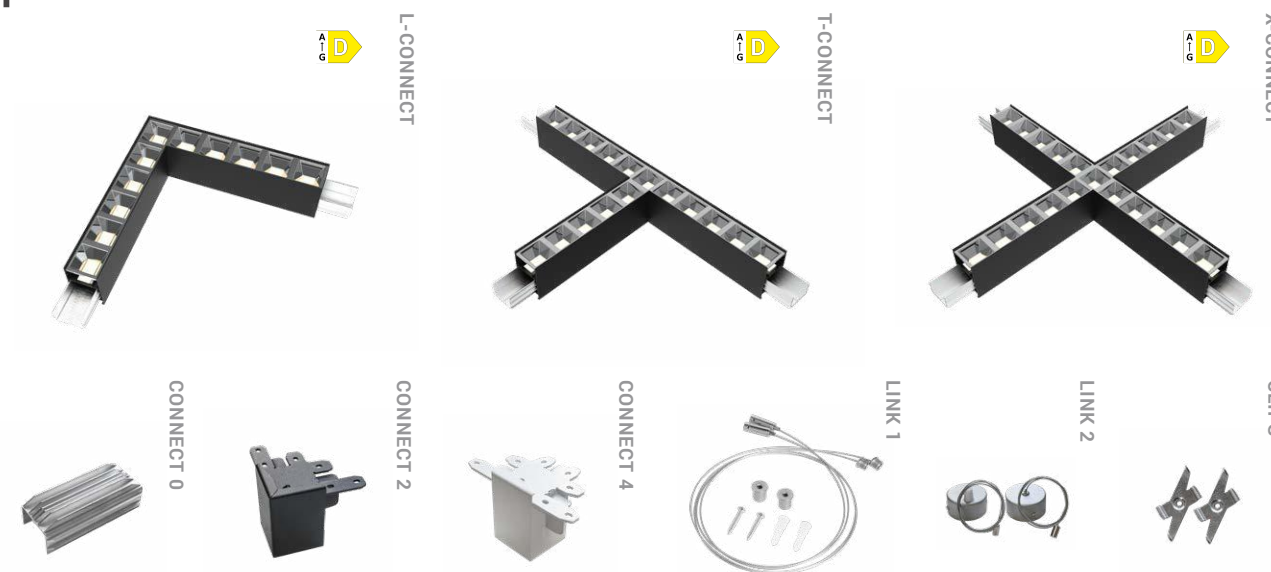

Index	Name	EAN	Description
ORO18041	ORO-RAGGIO-WHITE-LED-L-CONNECT	5902533196197	Łącznik świecący typu L biały / L-type white light connector / Bílý světelný konektor typu L / Biely svetelný konektor typu L
ORO18042	ORO-RAGGIO-SILVER-LED-L-CONNECT	5902533196203	Łącznik świecący typu L srebrny / L-type silver light connector / Stříbrný světelný konektor typu L / Strieborný svetelný konektor typu L
ORO18043	ORO-RAGGIO-BLACK-LED-L-CONNECT	5902533196210	Łącznik świecący typu L czarny / L-type black light connector / Černý světelný konektor typu L / Čierny svetelný konektor typu L
ORO18044	ORO-RAGGIO-WHITE-LED-T-CONNECT	5902533196227	Łącznik świecący typu T biały / T-type white light connector / Bílý světelný konektor typu T / Biely svetelný konektor typu T
ORO18045	ORO-RAGGIO-SILVER-LED-T-CONNECT	5902533196234	Łącznik świecący typu T srebrny / T-type silver light connector / Stříbrný světelný konektor typu T / Strieborný svetelný konektor typu T
ORO18046	ORO-RAGGIO-BLACK-LED-T-CONNECT	5902533196241	Łącznik świecący typu T czarny / T-type black light connector / Černý světelný konektor typu T / Čierny svetelný konektor typu T
ORO18047	ORO-RAGGIO-WHITE-LED-X-CONNECT	5902533196258	Łącznik świecący typu X biały / X-type white light connector / Bílý světelný konektor typu X / Biely svetelný konektor typu X
ORO18048	ORO-RAGGIO-SILVER-LED-X-CONNECT	5902533196265	Łącznik świecący typu X srebrny / X-type silver light connector / Stříbrný světelný konektor typu X / Strieborný svetelný konektor typu X
ORO18049	ORO-RAGGIO-BLACK-LED-X-CONNECT	5902533196272	Łącznik świecący typu X czarny / X-type black light connector / Černý světelný konektor typu X / Čierny svetelný konektor typu X
ORO18040	ORO-RAGGIO-CONNECT-0	5902533196180	Łącznik prosty / Straight connector / Přímý konektor / Priamy konektor
ORO18062	ORO-RAGGIO-WHITE-CONNECT-2	5902533197774	Łącznik typu L biały / L-type white connector / Bílý konektor typu L / Biely konektor typu L
ORO18064	ORO-RAGGIO-WHITE-CONNECT-4	5902533197798	Łącznik typu T biały / T-type white connector / Bílý konektor typu T / Biely konektor typu T
ORO18051	ORO-RAGGIO-SILVER-CONNECT-2	5902533197002	Łącznik typu L srebrny / L-type silver connector / Stříbrný konektor typu L / Strieborný konektor typu L
ORO18053	ORO-RAGGIO-SILVER-CONNECT-4	5902533197026	Łącznik typu T srebrny / T-type silver connector / Stříbrný konektor typu T / Strieborný konektor typu T
ORO18061	ORO-RAGGIO-BLACK-CONNECT-2	5902533197767	Łącznik typu L czarny / L-type black connector / Černý konektor typu L / Čierny konektor typu L
ORO18063	ORO-RAGGIO-BLACK-CONNECT-4	5902533197781	Łącznik typu T czarny / T-type black connector / Černý konektor typu T / Čierny konektor typu T
ORO18056	ORO-RAGGIO-CLIPS	5902533197057	Mocowanie natynkowe / Surface mounting / Povrchová montáž / Povrchová montáž
ORO18057	ORO-RAGGIO-LINK-1	5902533197064	Linka montażowa / Mounting rope / Montážní lano / Montážne lano
ORO18058	ORO-RAGGIO-LINK-WHITE-2	5902533197163	Rozeta z linką montażową biała / White rosette with mounting rope / Bílá rozeta s montážním lankem / Biela rozeta s montážnym lankom
ORO18059	ORO-RAGGIO-LINK-SILVER-2	5902533197743	Rozeta z linką montażową srebrna / Silver rosette with mounting rope / Stříbrná rozeta s montážním lankem / Strieborná rozeta s montážnym lankom
ORO18060	ORO-RAGGIO-LINK-BLACK-2	5902533197750	Rozeta z linką montażową czarna / Black rosette with mounting rope / Černá rozeta s montážním lankem / Čierna rozeta s montážnym lankom

DALAS



Index	Name	EAN	Pon [W]	Φ360° [lm]	η [lm/W]	CCT [K]	L x W x H [mm]		
ORO18065	DALAS LED 38W NW-W	5902533199884	38	4000	105	4000	1200 x 70 x 50		1,16
ORO18066	DALAS LED 38W NW-B	5902533199891	38	4000	105	4000	1200 x 70 x 50		1,16
ORO18067	DALAS LED 38W NW-S	5902533199907	38	4000	105	4000	1200 x 70 x 50		1,16

DALAS CCT



5
years
warranty

WW NW CW
CCT

Index	Name	EAN	Pon [W]	Φ360° [lm]	η [lm/W]	CCT [K]	L x W x H [mm]		
ORO33151	ORO DALAS LED 30W CCT-W	5902533199280	30	3300	110	3000-4000-6500	1200 x 75 x 50		1,40
ORO33152	ORO DALAS LED 30W CCT-B	5902533199297	30	3300	110	3000-4000-6500	1200 x 75 x 50		1,40
ORO33153	ORO DALAS LED 30W CCT-S	5902533199303	30	3300	110	3000-4000-6500	1200 x 75 x 50		1,40

+



Index	Name	EAN	
ORO33160	ORO DALAS LINK I	5905972140066	<i>Łącznik prosty / Straight connector / Přímý konektor / Priamy konektor</i>

BLUR

3

years
warranty



Index	Name	EAN	Pon [W]	Φ360° [lm]	Φuse [lm]	η [lm/W]	CCT [K]	L x W x H [mm]	Ø [mm]	Icon 1	Icon 2	Icon 3	Weight [kg]
ORO21034	ORO BLUR LED 20W NW-W	5902533199785	20	2200	1800 ± 120°	110	4000	Ø 145 x 59	Ø 130	□	□	□	0,47
ORO21035	ORO BLUR LED 30W NW-W	5902533199792	30	3300	2700 ± 120°	110	4000	Ø 190 x 59	Ø 160	□	□	□	0,65

IN 220-240V 50Hz
100°
30 000 h
IP20 IP44
PF >0,95
ALU PS
40 °C -20
0,5m
A i G F

TOSA

WW NW CW

CCT



Index	Name	EAN	Pon [W]	Φ360° [lm]	Φuse [lm]	η [lm/W]	EEL	CCT [K]	L x W x H [mm]	Ø [mm]	Icon 1	Icon 2	Icon 3	Weight [kg]
ORO21030	ORO-TOSA-6W-CCT	5902533195633	6	480	400 ± 120°	80	G	3000-4000-6500	Ø 105 x 38	Ø 85	□	□	□	0,09
ORO21031	ORO-TOSA-16W-CCT	5902533195640	16	1600	1320 ± 120°	100	F	3000-4000-6500	Ø 165 x 47	Ø 145	□	□	□	0,17
ORO21032	ORO-TOSA-20W-CCT	5902533195657	20	2000	1680 ± 120°	100	F	3000-4000-6500	Ø 190 x 49	Ø 170	□	□	□	0,22
ORO21033	ORO-TOSA-24W-CCT	5902533195664	24	2400	2120 ± 120°	100	F	3000-4000-6500	Ø 215 x 49	Ø 195	□	□	□	0,27

IN 220-240V 50Hz
110°
15 000 h
IP20
PA PC
40 °C -20
0,5m
A i G F

ZUMA CCT

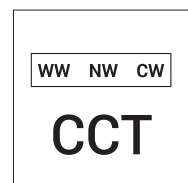
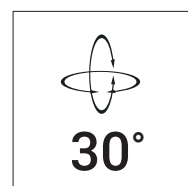

Index	Name	EAN	Pon [W]	Φ360° [lm]	Φuse [lm]	η [lm/W]	CCT [K]	L x W x H [mm]	Ø [mm]	Icon 1	Icon 2	Weight [kg]
ORO33109	ORO ZUMA LED R 5W CCT-B	5901752714403	5	475	375 $\lt; \lt; 90^\circ$	95	3000-4000-6500	Ø 85 x 38	Ø 70	Black	Light	0,57
ORO33108	ORO ZUMA LED R 5W CCT-W	5901752714106	5	475	375 $\lt; \lt; 90^\circ$	95	3000-4000-6500	Ø 85 x 38	Ø 70	White	Light	0,57
ORO33113	ORO ZUMA LED R 9W CCT-B	5901752715134	9	855	675 $\lt; \lt; 90^\circ$	95	3000-4000-6500	Ø 110 x 42	Ø 70	Black	Light	0,60
ORO33112	ORO ZUMA LED R 9W CCT-W	5901752715103	9	855	675 $\lt; \lt; 90^\circ$	95	3000-4000-6500	Ø 110 x 42	Ø 70	White	Light	0,60
ORO33111	ORO ZUMA LED S 5W CCT-B	5901752714427	5	475	375 $\lt; \lt; 90^\circ$	95	3000-4000-6500	85 x 85 x 38	Ø 95	Black	Light	0,87
ORO33110	ORO ZUMA LED S 5W CCT-W	5901752714410	5	475	375 $\lt; \lt; 90^\circ$	95	3000-4000-6500	85 x 85 x 38	Ø 95	White	Light	0,87
ORO33115	ORO ZUMA LED S 9W CCT-B	5901752715172	9	855	675 $\lt; \lt; 90^\circ$	95	3000-4000-6500	110 x 110 x 42	Ø 95	Black	Light	0,89
ORO33114	ORO ZUMA LED S 9W CCT-W	5901752715165	9	855	675 $\lt; \lt; 90^\circ$	95	3000-4000-6500	110 x 110 x 42	Ø 95	White	Light	0,89

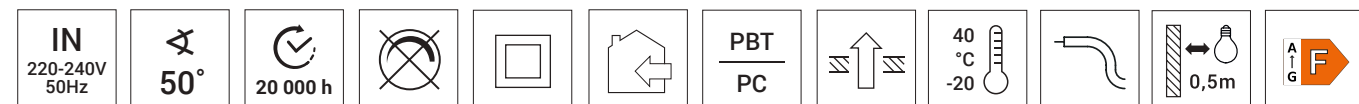

NEPTUN

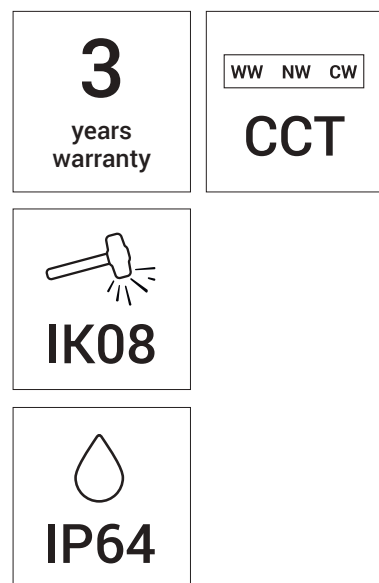

NEPTUN



NEPTUN CCT

Index	Name	EAN	Pon [W]	Φ360° [lm]	EEI	η [lm/W]	CCT [K]	L x W x H [mm]			[kg]
ORO26014	ORO-NEPTUN-24W-DW **	5902533194476	24	2475	F	103	4000	∅ 280 x 60			0,66
ORO26015	ORO-NEPTUN-24W-DW-MIC **	5902533194483	24	2475	F	103	4000	∅ 280 x 60			0,70
ORO33157	ORO NEPTUN LED 12W CCT	5905972140035	12	1560	E	130	3000-4000-6500	∅ 220 x 53			0,49
ORO33184	ORO NEPTUN LED 12W CCT MIC	5905972140301	12	1560	E	130	3000-4000-6500	∅ 220 x 53			0,49
ORO33158	ORO NEPTUN LED 18W CCT	5905972140042	18	2340	E	130	3000-4000-6500	∅ 280 x 53			0,8
ORO33185	ORO NEPTUN LED 18W CCT MIC	5905972140318	18	2340	E	130	3000-4000-6500	∅ 280 x 53			0,8
ORO33159	ORO NEPTUN LED 24W CCT	5905972140059	24	3120	E	130	3000-4000-6500	∅ 330 x 53			1,04
ORO33186	ORO NEPTUN LED 24W CCT MIC	5905972140325	24	3120	E	130	3000-4000-6500	∅ 330 x 53			1,04

* Oprawa z mikrofalowym czujnikiem ruchu bez regulacji Luminaire with a microwave motion sensor without regulation
Svítidlo s mikrovlnným pohybovým senzorem bez regulácie Svietidlo s mikrovlnným snímačom pohybu bez regulácie

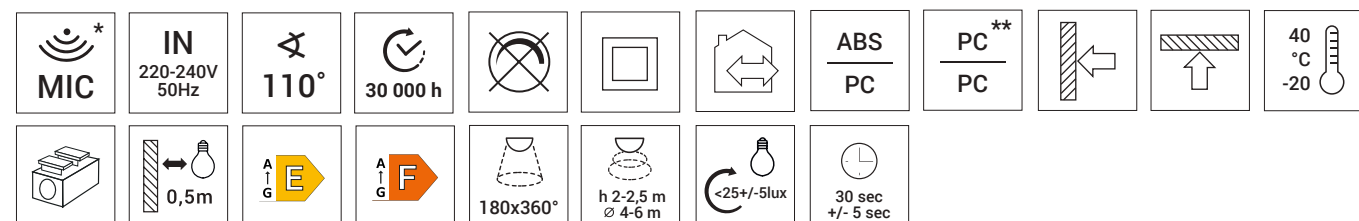

URAN



Index	Name	EAN	Pon [W]	Φmod [lm]	Φ360° [lm]	η [lm/W]	CCT [K]	L x W x H [mm]			[kg]
ORO26006	ORO-URAN-12W-DW	5902533191932	12	1400	950	79	4000	∅ 219 x 70			0,3
ORO33085	ORO-URAN-12W-DW-MIC	5901752711044	12	1400	950	79	4000	∅ 219 x 70			0,3
ORO26007	ORO-URAN-18W-DW	5902533191949	18	2100	1380	77	4000	∅ 267 x 85			0,4
ORO26008	ORO-URAN-18W-DW-MIC	5902533191956	18	2100	1380	77	4000	∅ 267 x 85			0,5
ORO26009	ORO-URAN-24W-DW	5902533193936	24	2800	1680	70	4000	∅ 306 x 95			0,5
ORO26010	ORO-URAN-24W-DW-MIC	5902533193943	24	2800	1680	70	4000	∅ 306 x 95			0,6

* Oprawa z mikrofalowym czujnikiem ruchu bez regulacji Luminaire with a microwave motion sensor without regulation
Svítidlo s mikrovlnným pohybovým senzorem bez regulácie Svietidlo s mikrovlnným snímačom pohybu bez regulácie

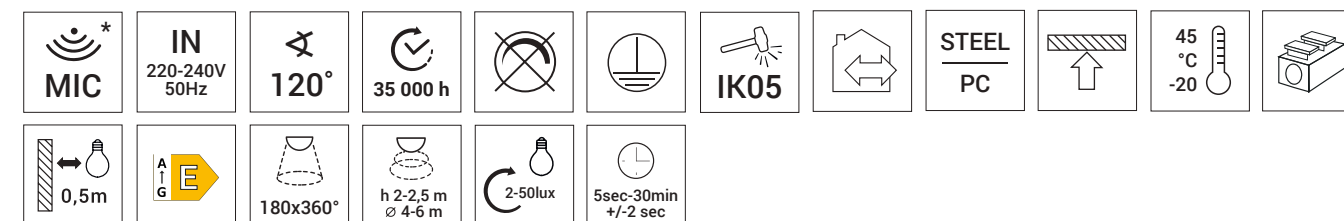

MARS

WW NW CW
CCT

CRI > 90**



Index	Name	EAN	Pon [W]	Φmod [lm]	Φ360° [lm]	η [lm/W]	EEL	CCT [K]	L x W x H [mm]		
ORO26016	ORO-MARS-12W-DW	5902533194575	12	1300	840	70	F	4000	∅ 260 x 60	<input type="checkbox"/>	0,28
ORO26017	ORO-MARS-18W-DW	5902533194582	18	2000	1500	83	F	4000	∅ 330 x 70	<input type="checkbox"/>	0,45
ORO26018	ORO-MARS-18W-DW-MIC	5902533194599	18	2000	1500	83	F	4000	∅ 330 x 70	<input type="checkbox"/>	0,43
ORO26019	ORO-MARS-24W-DW	5902533194605	24	2600	2000	83	F	4000	∅ 380 x 58	<input type="checkbox"/>	0,48
ORO26020	ORO-MARS-24W-DW-MIC	5902533194612	24	2600	2000	83	F	4000	∅ 380 x 58	<input type="checkbox"/>	0,69
ORO33138	ORO MARS LED 12W CCT **	5902533193370	12	1440	900	75	E	3000-4000-6500	∅ 290 x 70	<input type="checkbox"/>	0,40
ORO33139	ORO MARS LED 18W CCT **	5902533193387	18	2160	1350	75	E	3000-4000-6500	∅ 330 x 70	<input type="checkbox"/>	0,41
ORO33140	ORO MARS LED 24W CCT **	5902533193394	24	2880	1800	75	E	3000-4000-6500	∅ 380 x 70	<input type="checkbox"/>	0,52

* Oprava z prázdným mikrovlnným čidlem Luminaires with a constant microwave motion sensor
Svitidlo s nastaviteľným mikrovlnným pohybovým čidlom Svitidlo s nastaviteľným mikrovlnným pohybovým senzorom

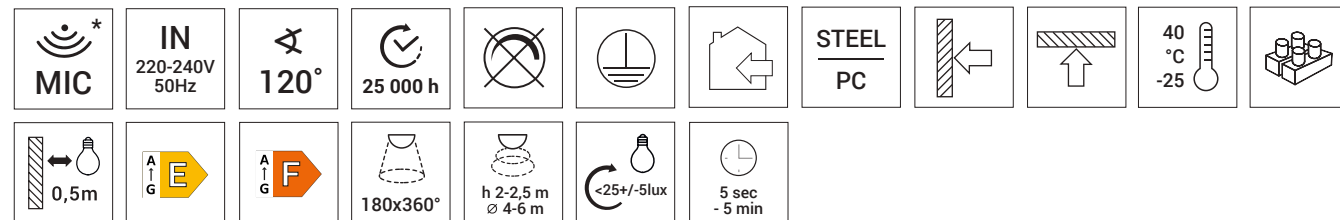

EGIR



Index	Name	EAN	Pon [W]	Φmod [lm]	Φ360° [lm]	η [lm/W]	CCT [K]	L x W x H [mm]		
ORO33103	ORO EGIR LED 12W NW-W	5901752712904	12	1360	720	60	4000	220 x 220 x 55	<input type="checkbox"/>	0,21
ORO33078	ORO EGIR LED 18W NW-W	5901752710863	18	2290	1260	70	4000	275 x 275 x 60	<input type="checkbox"/>	0,34
ORO33104	ORO EGIR LED 24W NW-W	5901752712911	24	2900	1680	70	4000	335 x 335 x 60	<input type="checkbox"/>	0,53
ORO33105	ORO EGIR LED 36W NW-W	5901752712928	36	4480	2340	65	4000	375 x 375 x 50	<input type="checkbox"/>	0,8



ETERNO

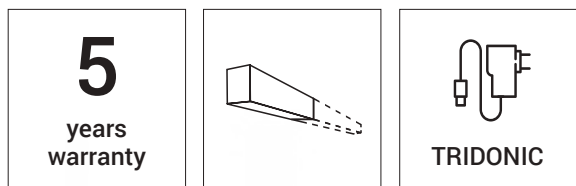

Index	Name	EAN	Pon [W]	Φ360° [lm]	Φuse [lm]	η [lm/W]	CCT [K]	L x W x H [mm]	⚡	⚖ [kg]
ORO18031	ORO-ETERNO-60W-DW-II-L	5902533193981	60	9000	8400 α 120°	150	4000	1275 x 112 x 89	■	4,13

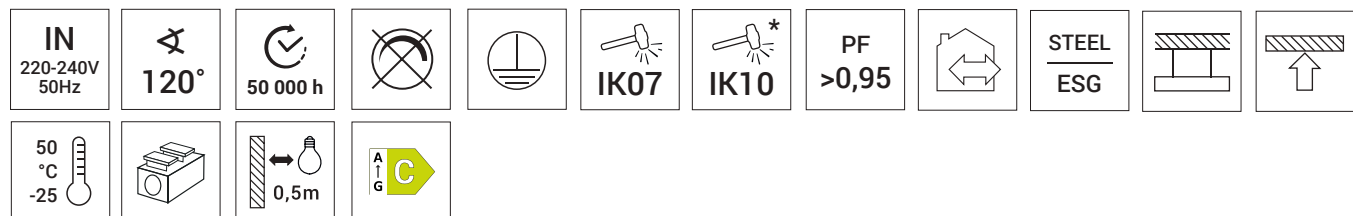

* Wyższe IK tylko podczas zastosowania siatki ochronnej ORO18012 Higher IK only when using the ORO18012 protective mesh
 Vyšší IK pouze při použití ochranné sítky ORO18012 Vyššie IK len pri použití ochrannej siete ORO18012

+



Index	Name	EAN	
ORO18012	ORO-GRID-ETERNO	5902533190256	Siatka ochronna IK10 / Protection grid IK10 / Ochranná mřížka IK10 / Ochranná mriežka IK10
ORO18013	ORO-FIX-ETERNO	5902533190263	Mocowanie ścienne z regulacją kąta / Wall mounting with angle adjustment / Montáž na stěnu s nastavením úhlu / Montáž na stenu s nastavením uhla
ORO18014	ORO-LINK-ETERNO	5902533190270	Linki montażowe / Installation lines / Instalační linky / Inštaláčňé linky
ORO18010	ORO-SENSO-ETERNO	5902533190232	Czujnik ruchu / Motion sensor / Pohybový senzor / Pohybový senzor



SFERIS

5 years warranty		 IP66	 IK08	 IK10
UGR <19	WW NW CW CCT	170 lm/W		



Index	Name	EAN	Pon [W]	Φ _{mod} [lm]	Φ _{360°} [lm]	η [lm/W]	CCT [K]	L x W x H [mm]			[kg]
ORO18030	ORO-SFERIS-18W-DW-L-III *	5902533193875	18	2880	2520	140	4000	640 x 107 x 76			0,7
ORO18033	ORO-SFERIS-40W-DW-L-III *	5902533194384	40	6400	5600	140	4000	1240 x 107 x 76			1,34
ORO18034	ORO-SFERIS-50W-DW-L-III *	5902533194568	50	8000	7000	140	4000	1540 x 107 x 76			1,55
ORO33162	ORO SFERIS LED 20W CCT S-DIMM **	5905972140080	20 / 18 15 / 13	-	3400 / 2870 2570 / 2230	170	3000-4000-6500	645 x 96 x 82			0,92
ORO33163	ORO SFERIS LED 38W CCT S-DIMM **	5905972140097	38 / 32 26 / 20	-	6460 / 5290 4500 / 3400	170	3000-4000-6500	1245 x 96 x 82			1,57
ORO33164	ORO SFERIS LED 54W CCT S-DIMM **	5905972140103	54 / 46 38 / 32	-	9180 / 7950 6770 / 5480	170	3000-4000-6500	1545 x 96 x 82			1,92

IN 220-240V 50Hz	 120°	 50 000 h							 50 °C -25		 0,5m
-------------------------------	-----------------	---------------------	--	--	--	--	--	--	------------------	--	----------

+



Index	Name	EAN	
ORO18006	ORO-LINK-SFERIS	5902533190188	Linki montażowe / Installation lines / Instalační linky / Inštaláčne linky
ORO18007	ORO-SENSO-SFERIS	5902533190195	Czujnik ruchu / Motion sensor / Pohybový senzor / Pohybový senzor

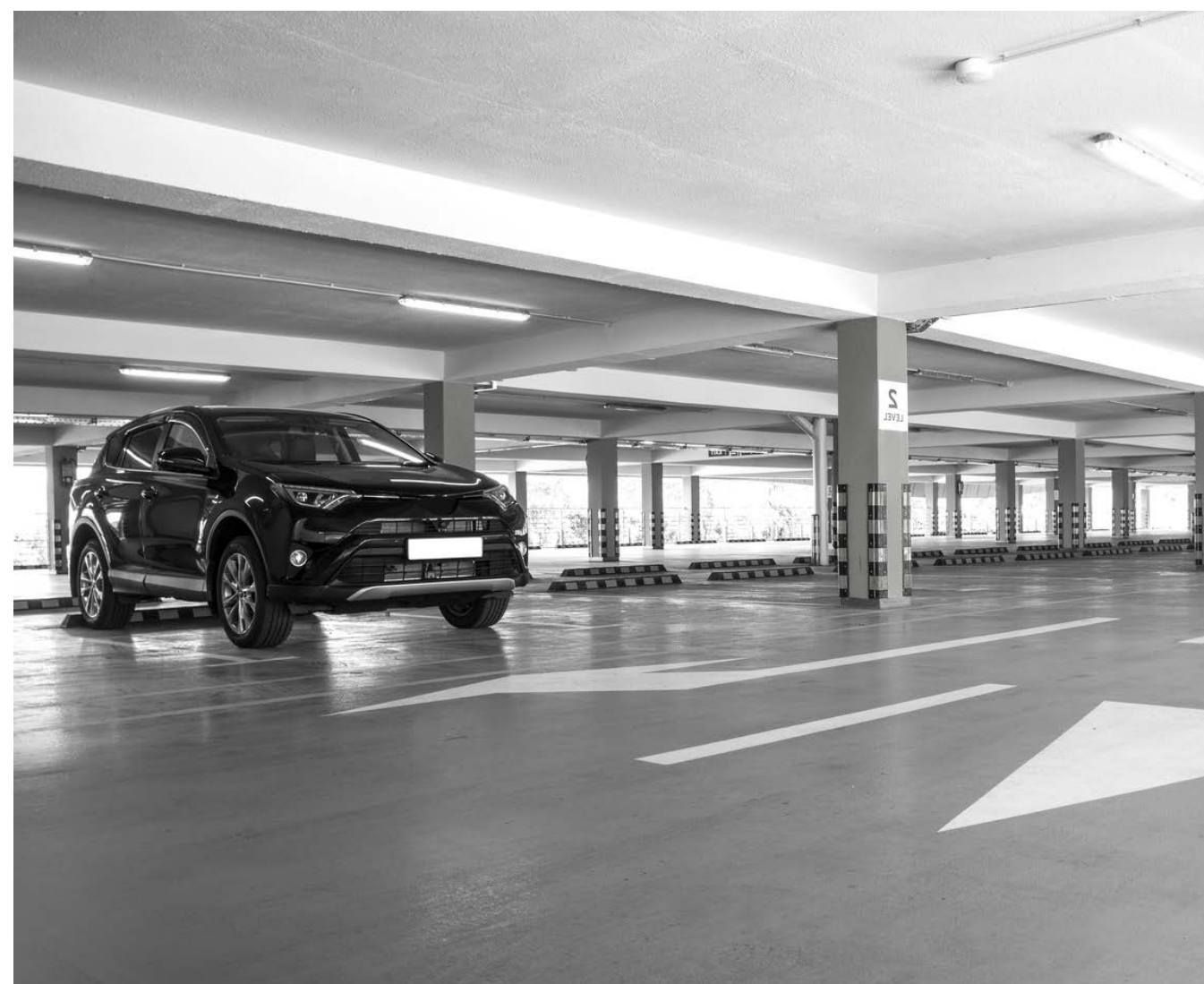

BALI

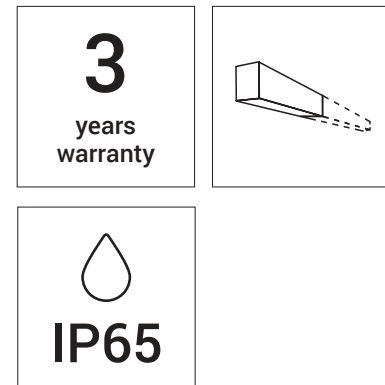

Index	Name	EAN	Pon [W]	Φ360° [lm]	η [lm/W]	CCT [K]	L x W x H [mm]		
ORO33165	ORO-BALI 20W-DW-L	5905972140110	20	2300	115	4000	580 x 75 x 66		0,59
ORO18036	ORO-BALI-50W-DW-L	5902533194636	50	5750	115	4000	1140 x 75 x 66		1,01
ORO33166	ORO-BALI-70W-DW-L	5905972140127	70	8050	115	4000	1480 x 75 x 66		1,33

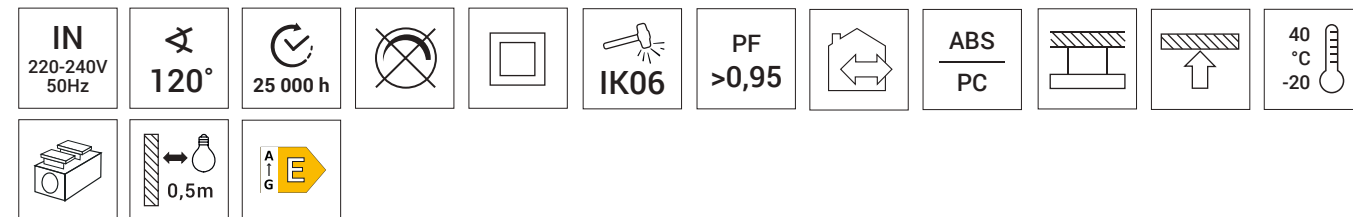

SEVA

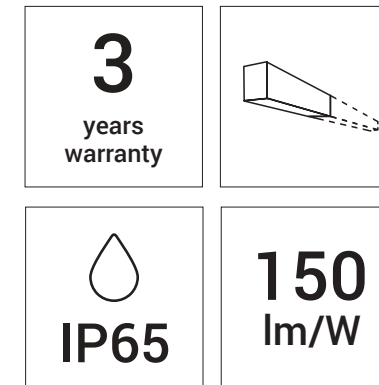

Index	Name	EAN	Pon [W]	Φ360° [lm]	η [lm/W]	CCT [K]	L x W x H [mm]		
ORO33075	ORO SEVA LED 18W NW	5901752710832	18	2700	150	4000	657 x 79 x 42		0,23
ORO33076	ORO SEVA LED 36W NW *	5901752710849	36	5400	150	4000	1257 x 79 x 42		0,40
ORO33077	ORO SEVA LED 48W NW *	5901752710856	48	7200	150	4000	1557 x 79 x 42		0,49

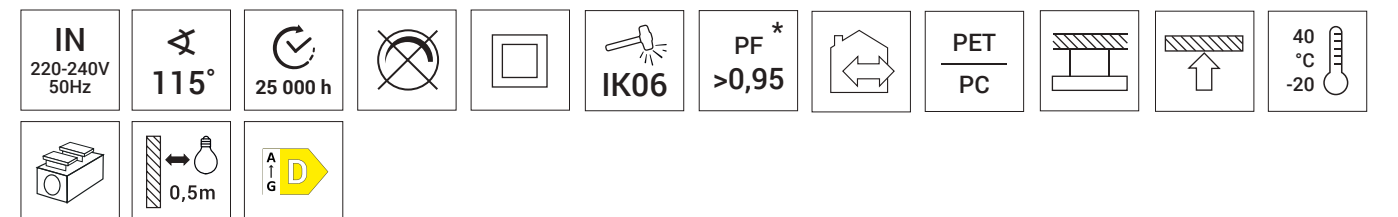

NITRA

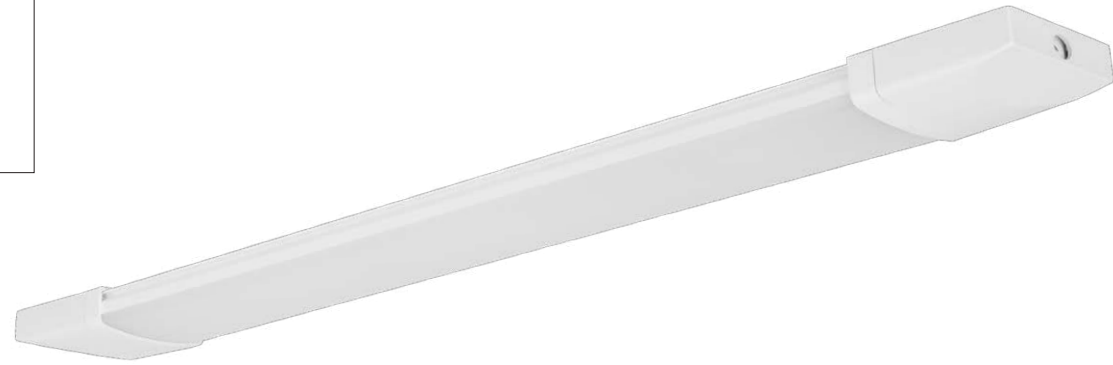
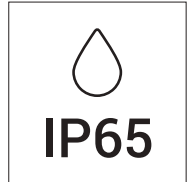
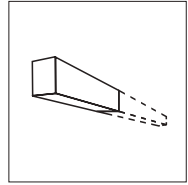

Index	Name	EAN	Pon [W]	Φ360° [lm]	η [lm/W]	CCT [K]	L x W x H [mm]		
ORO18023	ORO-NITRA-18W-DW-L	5902533191291	18	1850	103	4000	632 x 67 x 22		0,42
ORO18024	ORO-NITRA-36W-DW-L *	5902533191307	36	3900	108	4000	1230 x 67 x 22		0,71

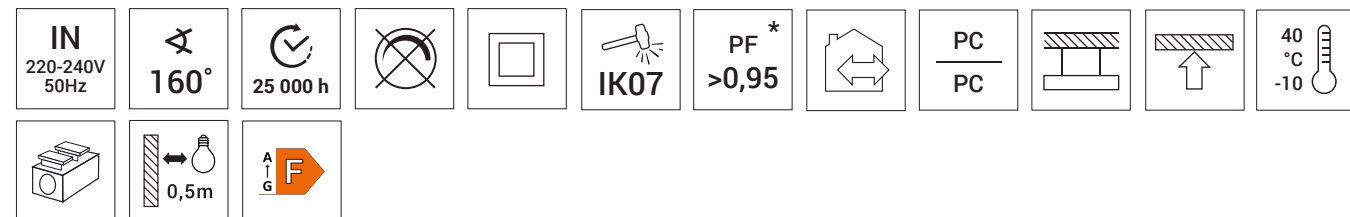

GRADO

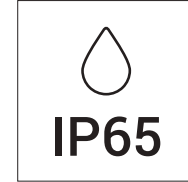
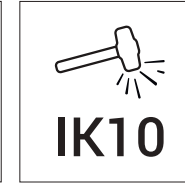
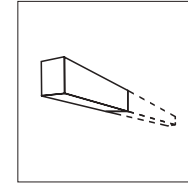

Index	Name	EAN	Pmax [W]	L x W x H [mm]		
ORO06013	ORO-GRADO-2XT8120	5901549640311	2 x 36	1265 x 128 x 88		1,66

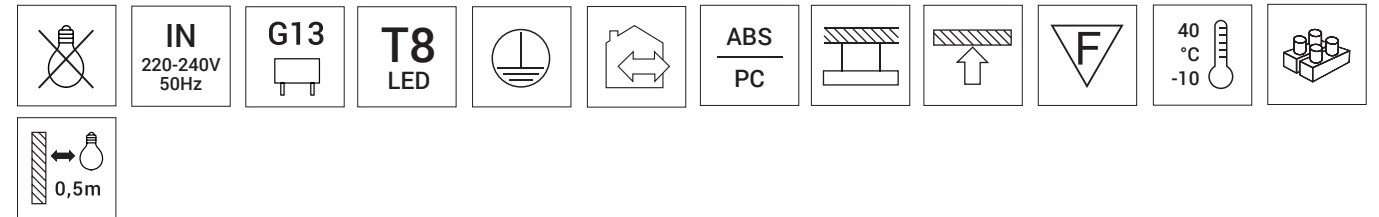

ATLAS

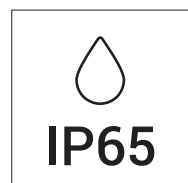
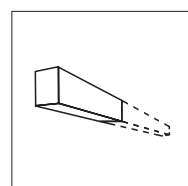

IP65



Index	Name	EAN	Pmax [W]	L x W x H [mm]		[kg]
ORO33079	ORO-ATLAS-1XT8120-G	5901752710986	1 x 36	1260 x 64 x 80		0,83
ORO06001	ORO-ATLAS-2XT860-G	5901752714472	2 x 18	660 x 96 x 80		0,62
ORO06002	ORO-ATLAS-2XT8120-G	5901752714489	2 x 36	1260 x 96 x 80		1,16
ORO06005	ORO-ATLAS-2XT8150-G	5902533190140	2 x 54	1560 x 96 x 80		1,51



Index	Name	EAN	
ORO06006	ORO-CLIPS-ATLAS	5902533191741	Zaczepek klosza / Luminaire clip / Háček stínidla / Háčik na tienidlo



ATLAS BASIC

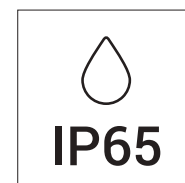
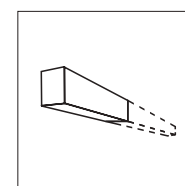

IP65



Index	Name	EAN	Pmax [W]	L x W x H [mm]		[kg]
ORO33137	ORO-ATLAS-BASIC-1XT8120	5902533192427	1 x 36	1265 x 65 x 58		0,52
ORO06014	ORO-ATLAS-BASIC-2XT860	5902533193530	2 x 18	673 x 104 x 65		0,45
ORO06015	ORO-ATLAS-BASIC-2XT8120	5902533193547	2 x 36	1283 x 104 x 65		0,74
ORO06016	ORO-ATLAS-BASIC-2XT8150	5902533193554	2 x 54	1583 x 104 x 65		0,98



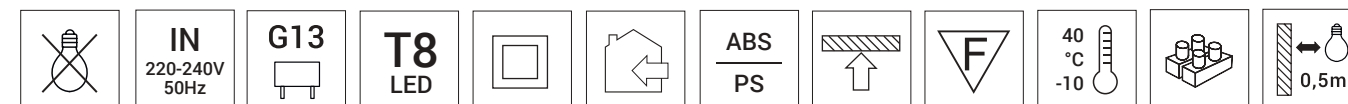

Index	Name	EAN	
ORO06017	ORO-CLIPS-ATLAS-BASIC	5902533193578	Zaczepek klosza / Luminaire clip / Háček stínidla / Háčik na tienidlo



PARED



Index	Name	EAN	Pmax [W]	L x W x H [mm]		 [kg]
ORO06012	ORO-PARED-2XT8120	5901549640274	2 x 22	1250 x 150 x 66	<input type="checkbox"/>	1,1





ARK



ARK 1 x T8



ARK 2 x T8

Index	Name	EAN	Pmax [W]	L x W x H [mm]		 [kg]
ORO06022	ARK T8 LED 1X60	5902533199839	1 x 9	630 x 42 x 47	<input type="checkbox"/>	0,17
ORO06023	ARK T8 LED 1X120	5902533199846	1 x 18	1230 x 42 x 47	<input type="checkbox"/>	0,31
ORO06024	ARK T8 LED 1X150	5902533199853	1 x 24	1530 x 42 x 47	<input type="checkbox"/>	0,45
ORO06025	ARK T8 LED 2X120	5902533199860	2 x 18	1230 x 100 x 47	<input type="checkbox"/>	0,32
ORO06026	ARK T8 LED 2X150	5902533199877	2 x 24	1530 x 100 x 47	<input type="checkbox"/>	0,45

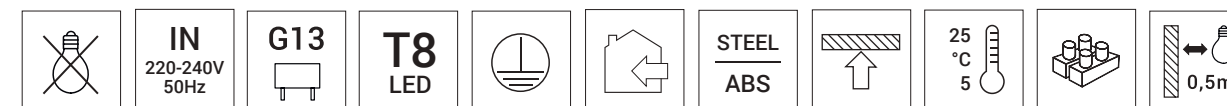

DISK

5
years
warranty

1-10V

IP65

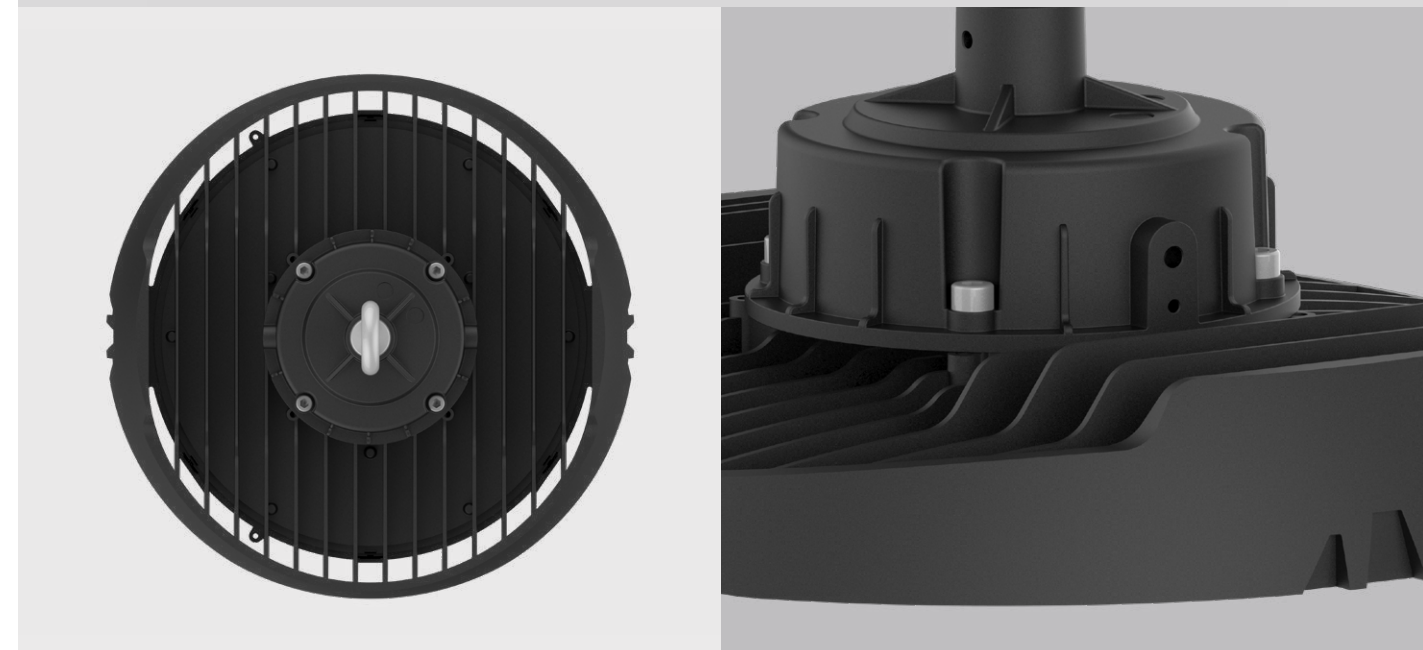
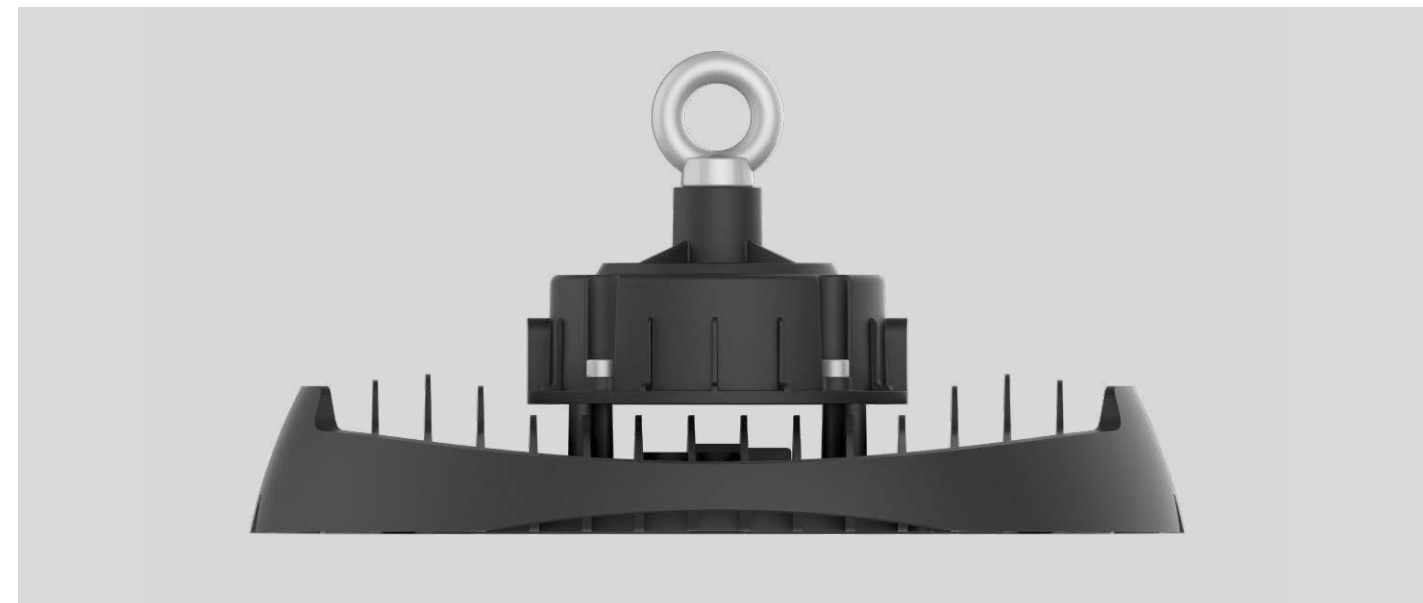

Index	Name	EAN	Pon [W]	Φ360° [lm]	Φuse [lm]	η [lm/W]	CCT [K]	L x W x H [mm]		
ORO19015	ORO-HB-DISK-200W-DW	5902533199310	200	28 000	20 200 \angle 90°	140	4000	∅ 320 x 174		2,64

IN
220-240V
50Hz

90°

40 000 h

IK07

PF
0,98

ALU
PC

45 °C
-35

0,5m

A
G
E



DIODO PRO

5
years
warranty

IP65

160
lm/W



Index	Name	EAN	Pon [W]	Φ360° [lm]	Φuse [lm]	η [lm/W]	CCT [K]	L x W x H [mm]		[kg]
ORO33129	ORO DIODO PRO 30W NW	5902533190850	30	4800	3900 α 120°	160	4000	165 x 153 x 34		0,41
ORO33130	ORO DIODO PRO 50W NW	5902533190867	50	8000	6500 α 120°	160	4000	184 x 169 x 34		0,56
ORO33131	ORO DIODO PRO 100W NW	5902533190874	100	16 000	13 000 α 120°	160	4000	254 x 243 x 40		1,10
ORO33132	ORO DIODO PRO 150W NW	5902533190881	150	24 000	19 500 α 120°	160	4000	329 x 295 x 43		1,78
ORO33133	ORO DIODO PRO 200W NW	5902533190898	200	32 000	26 000lm α 120°	160	4000	403 x 350 x 44		2,80

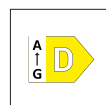

DIODO

3
years
warranty

IP65



Index	Name	EAN	Pon [W]	Φ360° [lm]	Φuse [lm]	η [lm/W]	CCT [K]	L x W x H [mm]		[kg]
ORO33120	ORO DIODO 10W NW	5902533190010	10	900	820 \leq 120°	90	4000	104 x 92 x 21		0,16
ORO33121	ORO DIODO 10W NW PIR *	5902533190027	10	900	820 \leq 120°	90	4000	145 x 127 x 71		0,19
ORO33122	ORO DIODO 20W NW	5902533190034	20	1800	1640 \leq 120°	90	4000	127 x 114 x 28		0,24
ORO33123	ORO DIODO 20W NW PIR *	5902533190041	20	1800	1640 \leq 120°	90	4000	145 x 127 x 71		0,27
ORO33124	ORO DIODO 30W NW	5902533190058	30	3000	2640 \leq 120°	100	4000	164 x 139 x 29		0,35
ORO33125	ORO DIODO 30W NW PIR *	5902533190157	30	3000	2640 \leq 120°	100	4000	167 x 164 x 79		0,38
ORO33126	ORO DIODO 50W NW	5902533190171	50	5000	4100 \leq 120°	100	4000	183 x 169 x 29		0,48
ORO33127	ORO DIODO 50W NW PIR *	5902533190560	50	5000	4100 \leq 120°	100	4000	198 x 183 x 79		0,51
ORO33128	ORO DIODO 100W NW	5902533190676	100	10 000	7580 \leq 120°	100	4000	254 x 217 x 33		0,97

* Naświetlacz z czujnikiem ruchu Floodlight with motion sensor Reflektor s pohybovým čídlom Reflektor s pohybovým senzorem

IN 220-240V 50Hz	110°	25 000 h			IP PIR 44	ALU GLASS	40 °C -20		0,5m
120°	h 2-3 m Ø 3-8 m	5-2000lux	7 sec -7 min						



ZONA

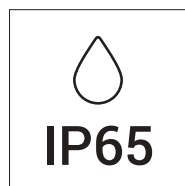

Index	Name	EAN	Pon [W]	Φ360° [lm]	Φuse [lm]	η [lm/W]	CCT [K]	L x W x H [mm]		
ORO33080	ORO ZONA LED 10W NW-B	5901752710993	10	900	730 \sphericalangle 120°	90	4000	93 x 73 x 24		0,16
ORO33068	ORO ZONA LED 10W NW-B PIR *	5901752710764	10	900	730 \sphericalangle 120°	90	4000	93 x 135 x 24		0,20
ORO33069	ORO ZONA LED 20W NW-B	5901752710771	20	1800	1600 \sphericalangle 120°	90	4000	114 x 89 x 24		0,22
ORO33070	ORO ZONA LED 20W NW-B PIR *	5901752710788	20	1800	1600 \sphericalangle 120°	90	4000	114 x 155 x 24		0,26
ORO33071	ORO ZONA LED 30W NW-B	5901752710795	30	2700	2400 \sphericalangle 120°	90	4000	143 x 105 x 26		0,32
ORO33072	ORO ZONA LED 30W NW-B PIR *	5901752710801	30	2700	2400 \sphericalangle 120°	90	4000	143 x 183 x 26		0,36
ORO33073	ORO ZONA LED 50W NW-B	5901752710818	50	4500	4000 \sphericalangle 120°	90	4000	182 x 142 x 30		0,58
ORO33074	ORO ZONA LED 50W NW-B PIR *	5901752710825	50	4500	4000 \sphericalangle 120°	90	4000	182 x 208 x 30		0,63

* Naświetlacz z czujnikiem ruchu Floodlight with motion sensor Reflektor s pohybovým čídlom Reflektor s pohybovým senzorum



MOBILE

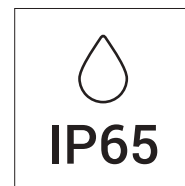

Index	Name	EAN	Pon [W]	Φ360° [lm]	Φuse [lm]	η [lm/W]	CCT [K]	L x W x H [mm]		
ORO33149	ORO MOBILE 30W NW	5902533196036	30	2550	2310 \sphericalangle 120°	85	4000	140 x 196 x 230		0,80
ORO33150	ORO MOBILE 50W NW	5902533197170	50	4250	3920 \sphericalangle 120°	85	4000	150 x 250 x 236		0,98



TRIPOD

3
years
warranty

IP65



Index	Name	EAN	Pon [W]	Φ360° [lm]	Φuse [lm]	η [lm/W]	CCT [K]	L x W x H [mm]		
ORO33148	ORO TRIPOD 2X30W NW	5902533196029	2 x 30	2 x 2550	2 x 2310 $\leq 120^\circ$	85	4000	800 x 800 x 1710		
ORO16095	ORO-DOUBLE-TRIPOD-1,5M-SET *	5902533197828	-	-	-	-	-	750 x 750 x 1550		

* Produkt kompatybilny z naświetlaczami. Zestaw nie zawiera naświetlacza Product compatible with floodlights. Does not include floodlights
Výrobek kompatibilní s reflektory. Sada neobsahuje reflektor Výrobek kompatibilný s reflektormi. Súprava neobsahuje reflektor

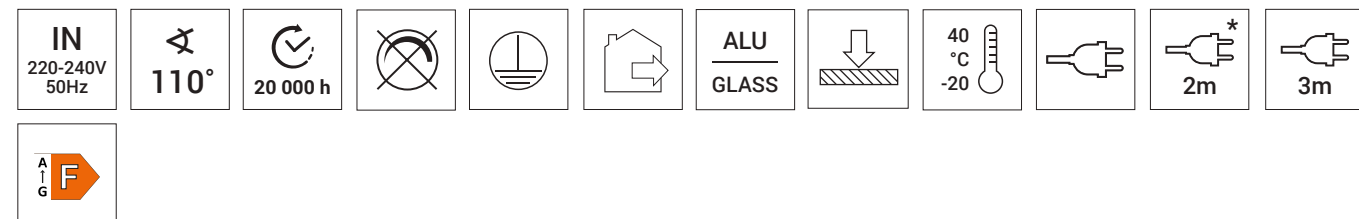

GOZO I KOS

3
years
warranty

IP65



Index	Name	EAN	Pon [W]	Φmod [lm]	Φ360° [lm]	η [lm/W]	CCT [K]	L x W x H [mm]		
ORO27005	ORO-GOZO-15W-DW-II	5902533194490	15	1500	1100	73	4000	∅ 182 x 66		
ORO27006	ORO-GOZO-15W-DW-SM-II *	5902533194506	15	1500	1100	73	4000	∅ 182 x 66		
ORO27007	ORO-KOS-15W-DW-II	5902533194513	15	1500	1100	73	4000	223 x 133 x 68		
ORO27008	ORO-KOS-15W-DW-SM-II *	5902533194520	15	1500	1100	73	4000	223 x 133 x 68		

* Oprawa z czujnikiem ruchu PIR Luminaire with a PIR motion sensor Svítidlo s čidlom pohybu PIR Svietidlo so snímačom pohybu PIR

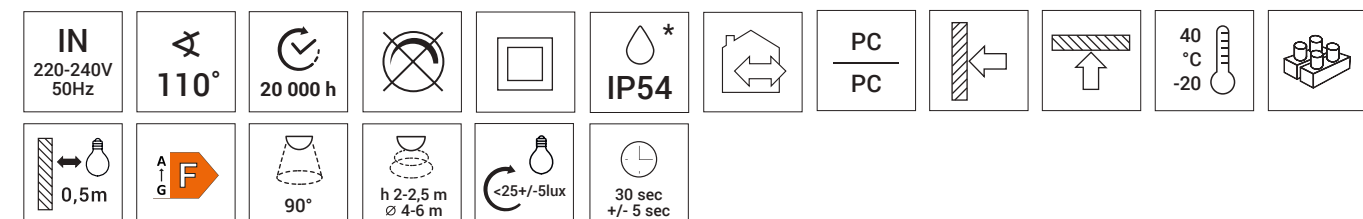

FALENA

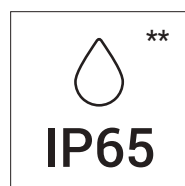

FALENA 1



FALENA 2



FALENA 3



FALENA 4

Index	Name	EAN	Pon [W]	Φmod [lm]	Φ360° [lm]	Φuse [lm]	EEl	IP	α	CCT [K]	L x W x H [mm]		[kg]
ORO10042	ORO-FALENA-6W-1-DW	5902533197187	6	2 x 190	2 x 100	2 x 90 ↙ 90°	G	54	2x98°	4000	100 x 100 x 93		0,60
ORO10043	ORO-FALENA-8W-2-DW ***	5902533197194	8	-	700	-	F	65	145°	4000	∅ 165 x 58		0,30
ORO10044	ORO-FALENA-9W-3-DW	5902533197200	9	4 x 200	4 x 140	4 x 120 ↙ 90°	F	54	4x90°	4000	∅ 105 x 75		0,41
ORO10045	ORO-FALENA-7,2W-4-DW **	5902533197217	7,2	620	2 x 260	2 x 235 ↙ 90°	F	65	2x90°	4000	170 x 80 x 40		0,45



NYX

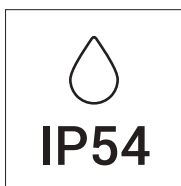

NYX 1



NYX 2



NYX 3

Index	Name	EAN	Pmax [W]	L x W x H [mm]		[kg]
ORO10051	ORO-NYX-1-E27	5902533197279	1 x 10	121 x 121 x 221		1,01
ORO10052	ORO-NYX-2-E27	5902533197286	2 x 10	136 x 136 x 380		2,01
ORO10053	ORO-NYX-3-E27	5902533197293	1 x 10	260 x 250 x 110		1,75

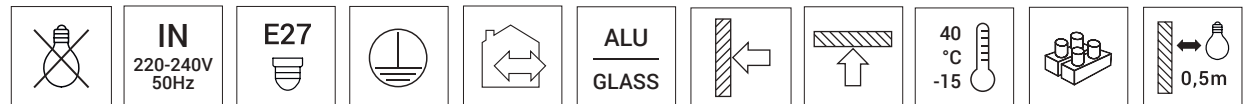

WENA E27

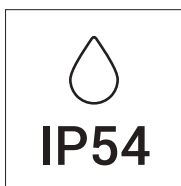

WENA ORO10032



WENA ORO10058



WENA ORO10033



WENA ORO10034

Index	Name	EAN	Pmax [W]	L x W x H [mm]		[kg]
ORO10032	WENA E27 *	5902533190485	10	194 x 162 x 232		0,59
ORO10033	WENA E27 *	5902533190492	10	194 x 162 x 232		0,57
ORO10058	WENA E27 **	5902533197347	10	165 x 165 x 300		0,55
ORO10034	WENA E27 ***	5902533190508	10	170 x 170 x 840		0,65

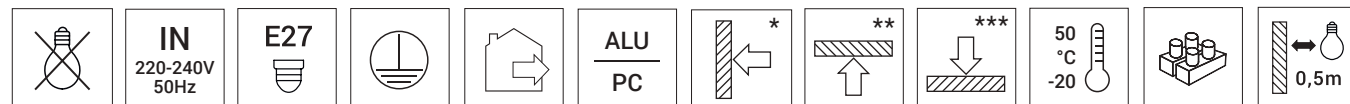

WENA

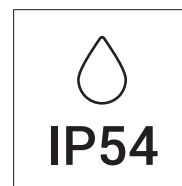

WENA ORO10028



WENA ORO10027



WENA ORO10029

Index	Name	EAN	Pon [W]	Φ360° [lm]	CCT [K]	L x W x H [mm]		[kg]
ORO10027	WENA *	5901752713666	7	590	3000	194 x 162 x 232		0,68
ORO10028	WENA *	5901752714045	7	590	3000	194 x 162 x 232		0,70
ORO10029	WENA **	5901752714090	7	590	3000	165 x 165 x 280		0,69

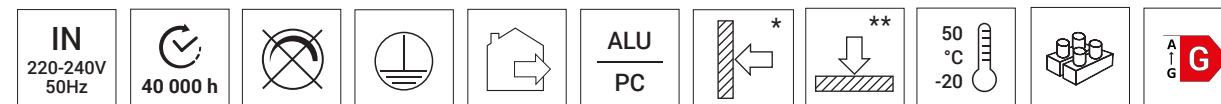

MALTA

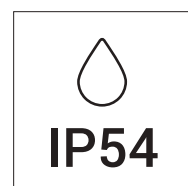

Index	Name	EAN	Pon [W]	Φ360° [lm]	Φuse [lm]	CCT [K]	L x W x H [mm]		
ORO10007	MALTA	5901752713277	4,9W	2 x 330	2x280 \sphericalangle 90°	3000	115 x 30 x 90		0,39

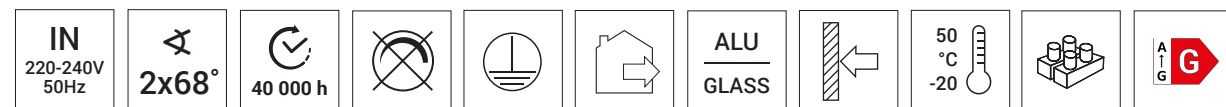

LIMA

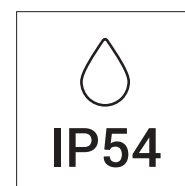

Index	Name	EAN	Pmax [W]	L x W x H [mm]		
ORO10026	LIMA	5901752713598	10	113 x 130 x 290		0,91

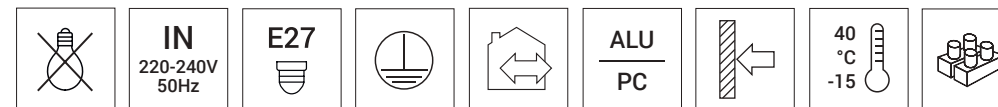

WEL

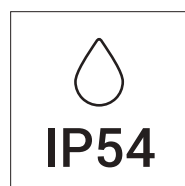

Index	Name	EAN	Pmax [W]	L x W x H [mm]		
ORO10054	ORO-WEL-E27	5902533197309	10	∅ 200 x 250		0,51

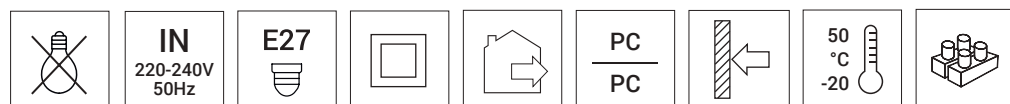

REGA

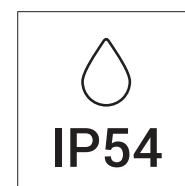

Index	Name	EAN	Pmax [W]	L x W x H [mm]		
ORO10057	ORO-REGA-GU10	5902533197330	4	95 x 70 x 80		0,15

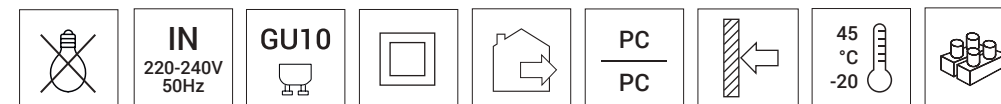

LEO

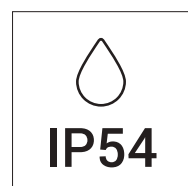

Index	Name	EAN	Pon [W]	Φ360° [lm]	CCT [K]	L x W x H [mm]		
ORO10006	LEO	5901752713246	6	350	3000	70 x 200 x 600		1,02



LIDO

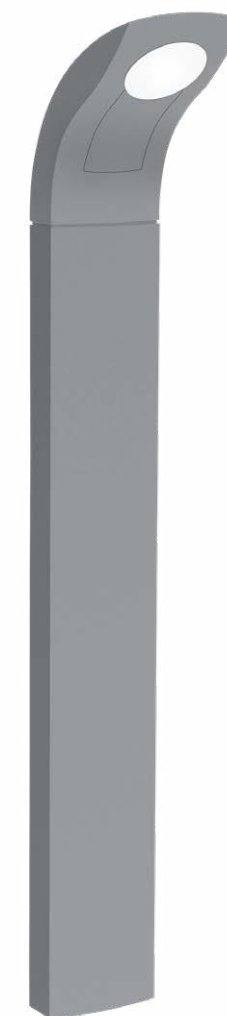
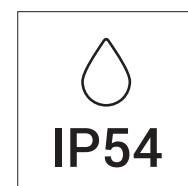

LIDO ORO10002



LIDO ORO10001

Index	Name	EAN	Pon [W]	Φ360° [lm]	CCT [K]	L x W x H [mm]		
ORO10001	LIDO *	5901752712867	6	350	3000	100 x 195 x 164		1,25
ORO10002	LIDO **	5901752712874	6	350	3000	100 x 160 x 800		2,30

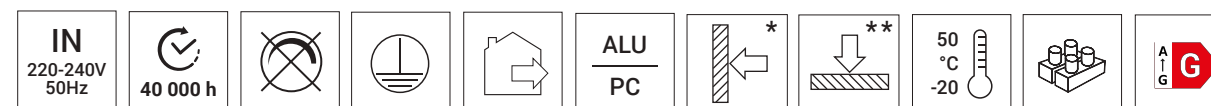

02

CONSUMER LUMINAIRES

OPRAWY KONSUMENCKIE / SPOTŘEBNÍ SVÍTIDLA
/ SPOTREBITELSKÉ SVIETIDLÁ

NUBE

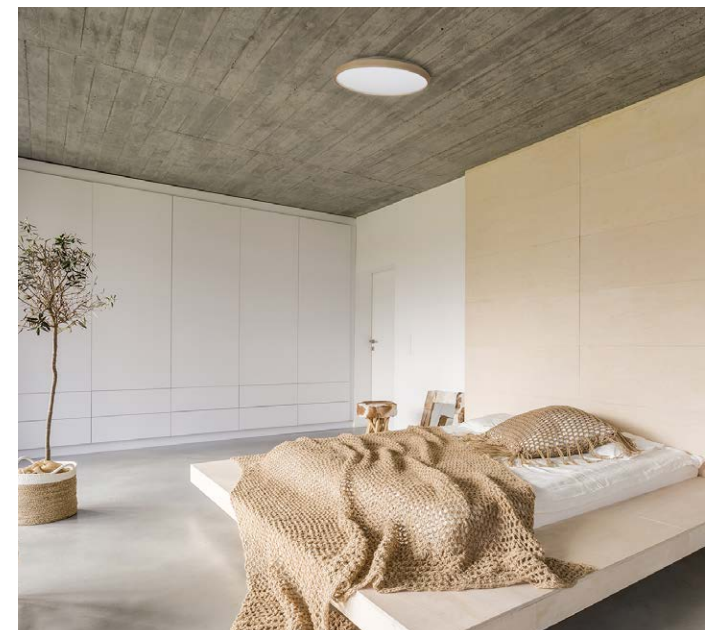
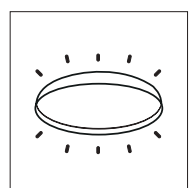

Index	Name	EAN	Pon [W]	Φmod [lm]	Φ360° [lm]	CCT [K]	L x W x H [mm]		[kg]
ORO33088	ORO-NUBE-BLACK-18W-DW	5901752711075	18	1850	1080	4000	∅ 290 x 65		0,51
ORO33091	ORO-NUBE-BLACK-24W-DW	5901752711105	24	2500	1440	4000	∅ 327 x 65		0,58
ORO26025	ORO-NUBE-BLACK-36W-DW	5902533195503	36	3850	2160	4000	∅ 385 x 65		0,80
ORO26029	ORO-NUBE-BLACK-60W-DW	5902533199372	60	6500	3900	4000	∅ 480 x 65		1,14
ORO33086	ORO-NUBE-GOLD-18W-DW	5901752711051	18	1850	1080	4000	∅ 290 x 65		0,51
ORO33089	ORO-NUBE-GOLD-24W-DW	5901752711082	24	2500	1440	4000	∅ 327 x 65		0,58
ORO26023	ORO-NUBE-GOLD-36W-DW	5902533195480	36	3850	2160	4000	∅ 385 x 65		0,80
ORO26027	ORO-NUBE-GOLD-60W-DW	5902533199358	60	6500	3900	4000	∅ 480 x 65		1,14
ORO33087	ORO-NUBE-SILVER-18W-DW	5901752711068	18	1850	1080	4000	∅ 290 x 65		0,51
ORO33090	ORO-NUBE-SILVER-24W-DW	5901752711099	24	2500	1440	4000	∅ 327 x 65		0,58
ORO26024	ORO-NUBE-SILVER-36W-DW	5902533195497	36	3850	2160	4000	∅ 385 x 65		0,80
ORO26028	ORO-NUBE-SILVER-60W-DW	5902533199365	60	6500	3900	4000	∅ 480 x 65		1,14



OLMO

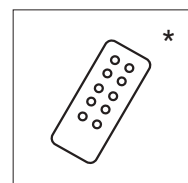
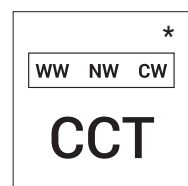

Index	Name	EAN	Pon [W]	Φmod [lm]	Φ360° [lm]	EEL	CCT [K]	L x W x H [mm]		
ORO33095	ORO-OLMO-18W-DW	5901752711228	18	2160	900	E	4000	∅ 292 x 70		0,51
ORO33096	ORO-OLMO-24W-DW	5901752711297	24	2880	1320	E	4000	∅ 340 x 70		0,58
ORO33097	ORO-OLMO-36W-DW	5901752711341	36	4320	2160	E	4000	∅ 390 x 70		0,82
ORO26021	ORO-OLMO-60W-DIM *	5902533195466	60	6400	3900	F	3000-4000-6500	∅ 491 x 78		1,77

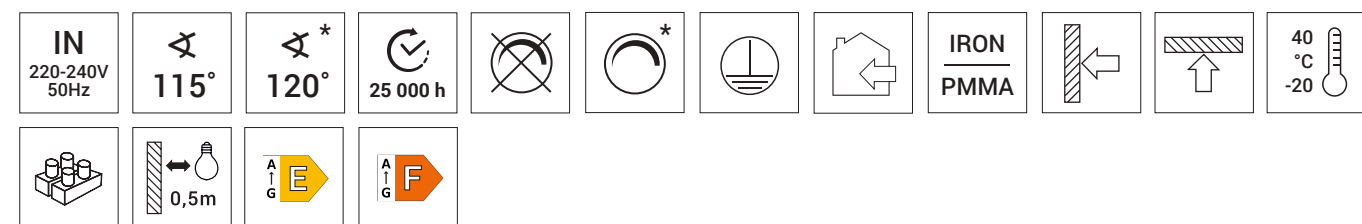

ORION



Index	Name	EAN	Pon [W]	Φmod [lm]	Φ360° [lm]	CCT [K]	L x W x H [mm]		
ORO26030	ORO-ORION-60W-DW	5902533199389	60	6500	3900	4000	∅ 507 x 79		1,73

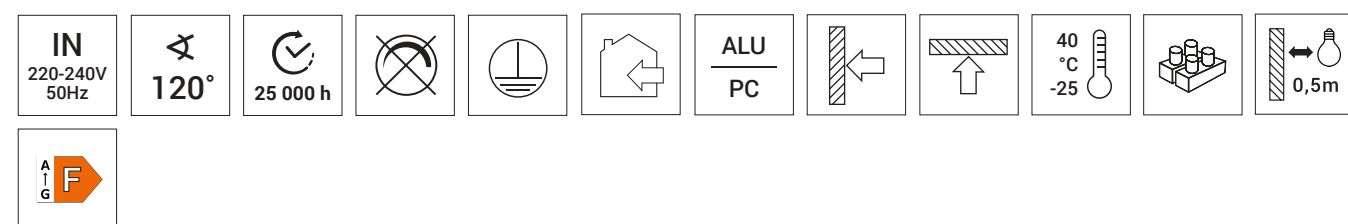

LUVIO

LUVIO R



LUVIO S



3
years
warranty

WW NW CW
CCT

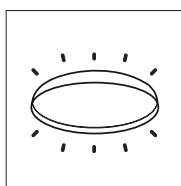

Index	Name	EAN	Pon [W]	Φ360° [lm]	η [lm/W]	CCT [K]	L x W x H [mm]	🔧	📦 [kg]
ORO33169	ORO LUVIO LED R 12W CCT	5905972140158	12	1200	100	3000-4000-6000	∅ 225 x 30	☐	0,40
ORO33170	ORO LUVIO LED R 18W CCT	5905972140165	18	1800	100	3000-4000-6000	∅ 300 x 30	☐	0,65
ORO33171	ORO LUVIO LED R 24W CCT	5905972140172	24	2410	100	3000-4000-6000	∅ 420 x 30	☐	1,10
ORO33172	ORO LUVIO LED S 12W CCT	5905972140189	12	1200	100	3000-4000-6000	225 x 225 x 30	☐	0,50
ORO33173	ORO LUVIO LED S 18W CCT	5905972140196	18	1800	100	3000-4000-6000	300 x 300 x 30	☐	0,80
ORO33174	ORO LUVIO LED S 24W CCT	5905972140202	24	2410	100	3000-4000-6000	420 x 420 x 30	☐	1,40

IN 220-240V 50Hz	115°	20 000 h	CRI > 85	IK06	PF > 0,9	PP/PP	0,5m	A G F
------------------------	------	----------	----------	------	----------	-------	------	-------



SATURN

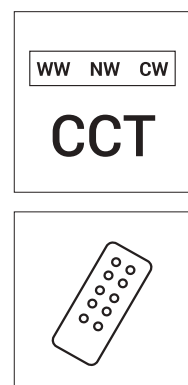

Index	Name	EAN	Pon [W]	Φmod [lm]	Φ360° [lm]	CCT [K]	L x W x H [mm]		
ORO26011	ORO-SATURN-60W-DIM	5902533193950	60	6400	3900	3000-4000-6500 	∅ 570 x 80		1,75

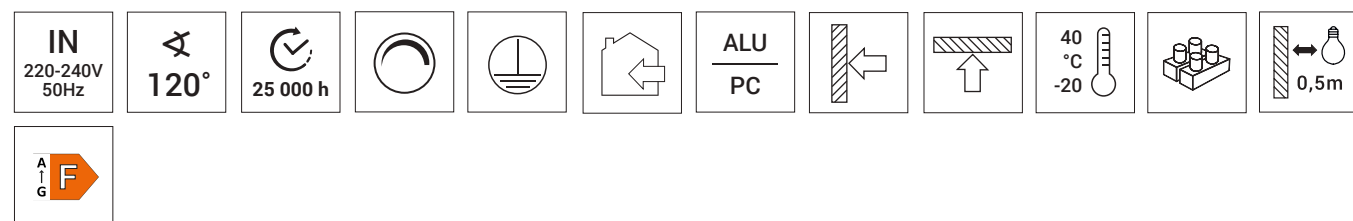

PRATO

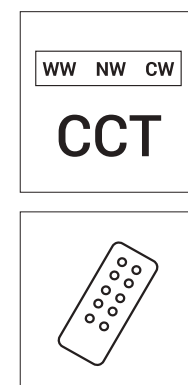

Index	Name	EAN	Pon [W]	Φmod [lm]	Φ360° [lm]	CCT [K]	L x W x H [mm]		
ORO26022	ORO-PRATO-60W-DIM	5902533195473	60	6400	3900	3000-4000-6500 	∅ 501 x 89		2,18

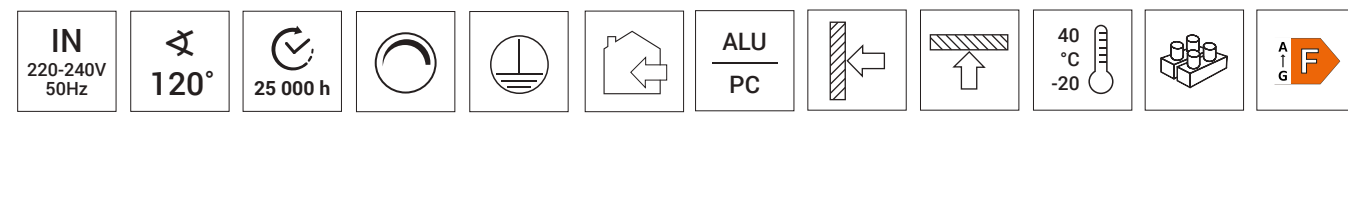

VENUS

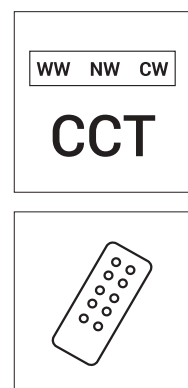

Index	Name	EAN	Pon [W]	Φmod [lm]	Φ360° [lm]	CCT [K]	L x W x H [mm]		
ORO26012	ORO-VENUS-60W-DIM	5902533193967	60	6400	3900	3000-4000-6500	∅ 500 x 106		1,53

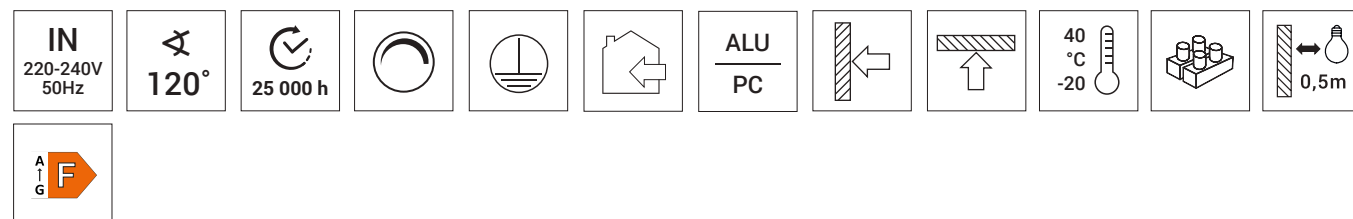

PETALO

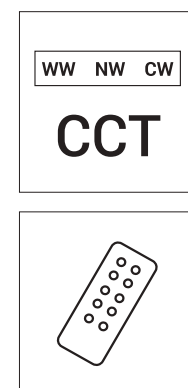

Index	Name	EAN	Pon [W]	Φmod [lm]	Φ360° [lm]	CCT [K]	L x W x H [mm]		
ORO26026	ORO-PETALO-80W-DIM	5902533196623	80	9600	7100	3000-4000-6500	∅ 750 x 110		3,26



LUMAGO

3

years
warranty



Index	Name	EAN	Pmax [W]	L x W x H [mm]		
ORO26001	ORO-LUMAGO-2	5901752719408	2 x 10	∅ 310 x 95		0,93

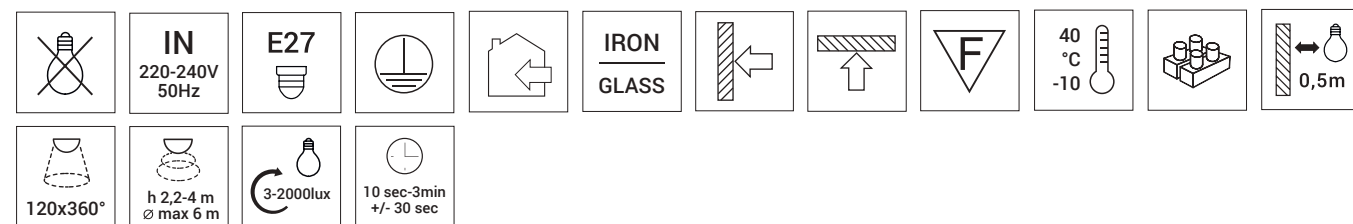

ARANA

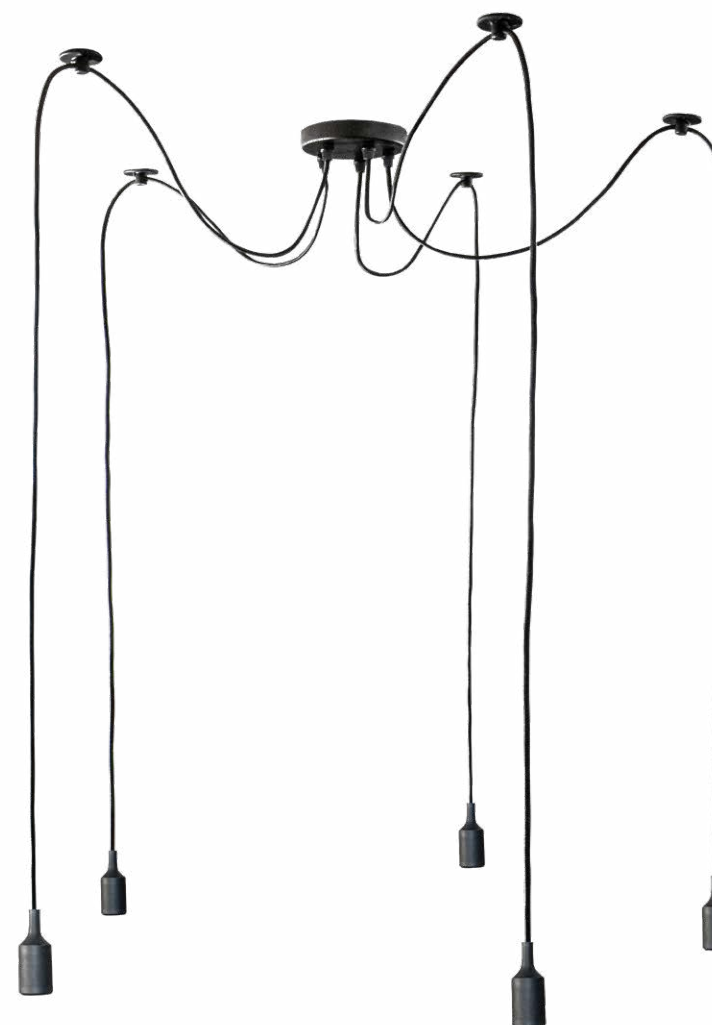



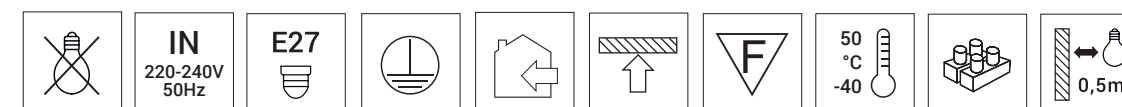



Index	Name	EAN	Pmax [W]	L x W x H [mm]		
ORO06021	ORO-ARANA-5XE27	5902533197736	5 x 20	∅ 1500 x 1000		0,94



AQUILA







Index	Name	EAN	Pmax [W]	L x W x H [mm]		 [kg]
ORO33005	ORO AQUILA 1XGU10 B/G	5901752710139	1 x 10	125 x 90 x 125		0,19
ORO33006	ORO AQUILA 2XGU10 B/G	5901752710146	2 x 10	300 x 90 x 150		0,40
ORO33007	ORO AQUILA 3XGU10 B/G	5901752710153	3 x 10	200 x 200 x 125		0,58
ORO33008	ORO AQUILA 4XGU10 B/G	5901752710160	4 x 10	640 x 90 x 150		0,72



BRANTA





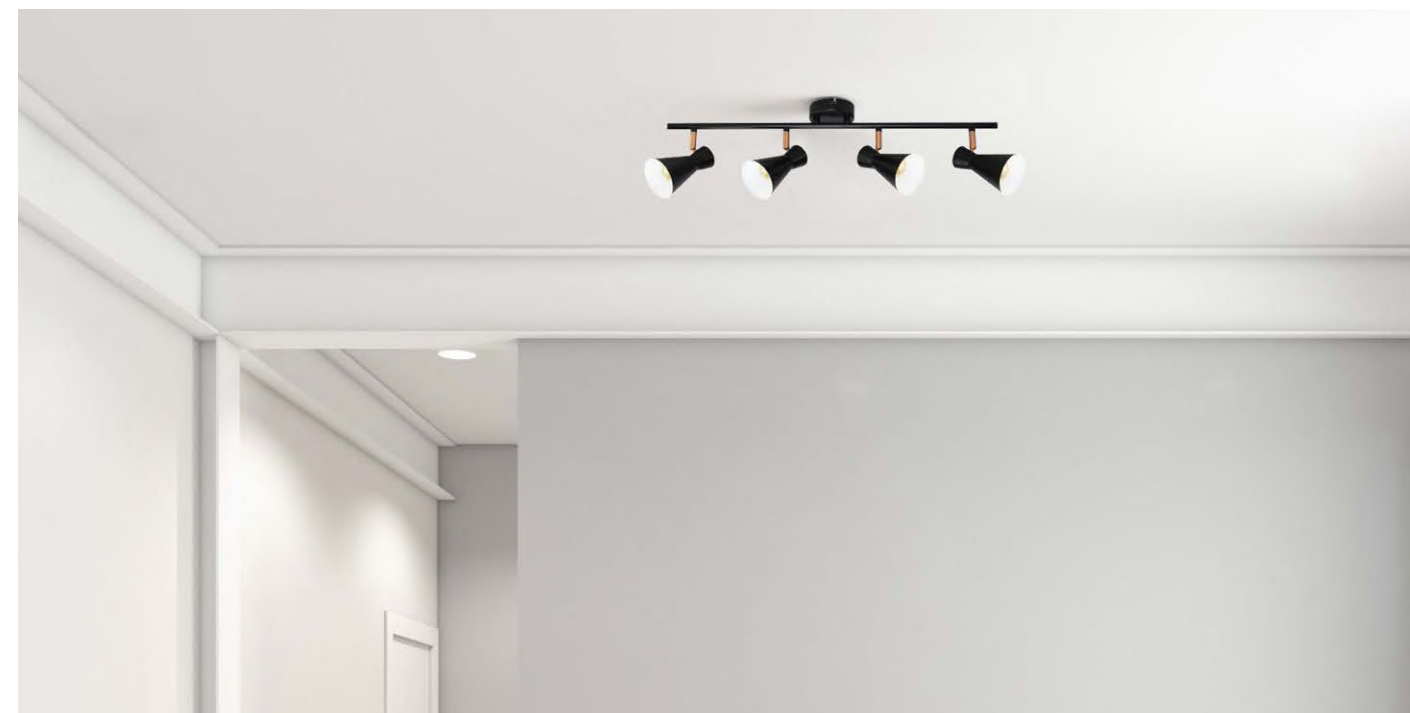



Index	Name	EAN	Pmax [W]	L x W x H [mm]		 [kg]
ORO33001	ORO BRANTA 1XE14 B/W	5902533199983	1 x 10	125 x 90 x 125		0,20
ORO33002	ORO BRANTA 2XE14 B/W	5902533199990	2 x 10	300 x 90 x 150		0,45
ORO33003	ORO BRANTA 3XE14 B/W	5901752710009	3 x 10	200 x 200 x 125		0,63
ORO33004	ORO BRANTA 4XE14 B/W	5901752710092	4 x 10	640 x 90 x 150		0,73



STERNA



Index	Name	EAN	Pmax [W]	L x W x H [mm]		 [kg]
OR033023	ORO STERNA 1XGU10 W	5901752710313	1 x 10	110 x 90 x 130		0,22
OR033024	ORO STERNA 2XGU10 W	5901752710320	2 x 10	250 x 90 x 135		0,44
OR033025	ORO STERNA 3XGU10 W	5901752710337	3 x 10	450 x 90 x 135		0,65
OR033026	ORO STERNA 4XGU10 W	5901752710344	4 x 10	640 x 90 x 135		0,83
OR033027	ORO STERNA 1XGU10 B	5901752710351	1 x 10	110 x 90 x 130		0,22
OR033028	ORO STERNA 2XGU10 B	5901752710368	2 x 10	250 x 90 x 135		0,44
OR033029	ORO STERNA 3XGU10 B	5901752710375	3 x 10	450 x 90 x 135		0,65
OR033030	ORO STERNA 4XGU10 B	5901752710382	4 x 10	640 x 90 x 135		0,83



GAVIA



Index	Name	EAN	Pmax [W]	L x W x H [mm]		 [kg]
ORO33009	ORO GAVIA 1XGU10 W	5901752710177	1 x 10	90 x 60 x 100	<input type="checkbox"/>	0,18
ORO33167	ORO GAVIA WS 1XGU10 W	5905972140134	1 x 10	100 x 90 x 100	<input type="checkbox"/>	0,20
ORO33010	ORO GAVIA 2XGU10 W	5901752710184	2 x 10	260 x 55 x 90	<input type="checkbox"/>	0,37
ORO33011	ORO GAVIA 3XGU10 W	5901752710191	3 x 10	450 x 55 x 90	<input type="checkbox"/>	0,57
ORO33012	ORO GAVIA 4XGU10 W	5901752710207	4 x 10	210 x 210 x 90	<input type="checkbox"/>	0,87
ORO33013	ORO GAVIA 5XGU10 W	5901752710214	5 x 10	640 x 55 x 90	<input type="checkbox"/>	0,92
ORO33014	ORO GAVIA 1XGU10 B	5901752710221	1 x 10	90 x 60 x 100	<input checked="" type="checkbox"/>	0,18
ORO33168	ORO GAVIA WS 1XGU10 B	5905972140141	1 x 10	100 x 90 x 100	<input checked="" type="checkbox"/>	0,20
ORO33015	ORO GAVIA 2XGU10 B	5901752710238	2 x 10	260 x 55 x 90	<input checked="" type="checkbox"/>	0,37
ORO33016	ORO GAVIA 3XGU10 B	5901752710245	3 x 10	450 x 55 x 90	<input checked="" type="checkbox"/>	0,57
ORO33017	ORO GAVIA 4XGU10 B	5901752710252	4 x 10	210 x 210 x 90	<input checked="" type="checkbox"/>	0,87
ORO33018	ORO GAVIA 5XGU10 B	5901752710269	5 x 10	640 x 55 x 90	<input checked="" type="checkbox"/>	0,92

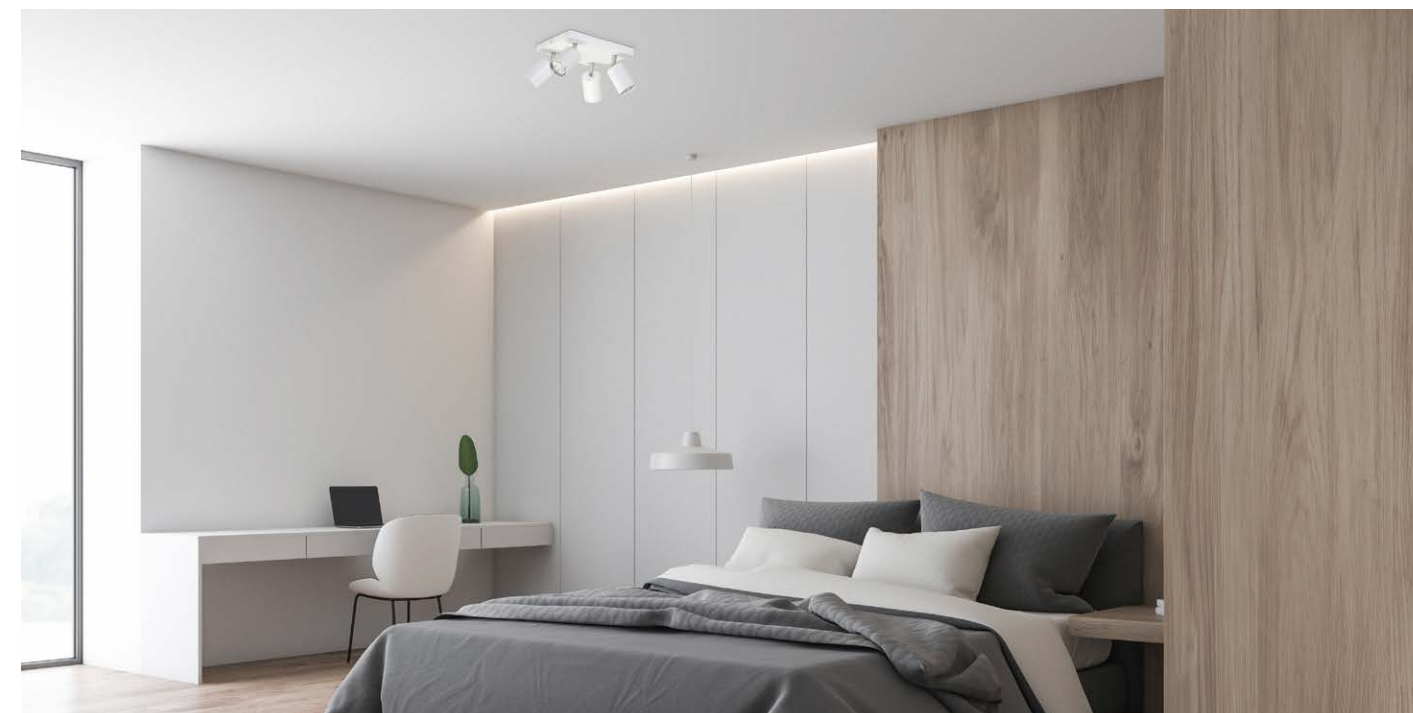

FALCO









Index	Name	EAN	Pmax [W]	L x W x H [mm]		 [kg]
OR033031	ORO FALCO 1XGU10 B/G	5901752710399	1 x 10	120 x 100 x 150		0,24
OR033032	ORO FALCO 2XGU10 B/G	5901752710405	2 x 10	300 x 90 x 175		0,49
OR033033	ORO FALCO 3XGU10 B/G	5901752710412	3 x 10	210 x 210 x 150		0,69
OR033034	ORO FALCO 4XGU10 B/G	5901752710429	4 x 10	640 x 90 x 175		0,87



TRINGA



Index	Name	EAN	Pmax [W]	L x W x H [mm]		 [kg]
ORO33019	ORO TRINGA 1XE14 B	5901752710276	1 x 10	140 x 100 x 150		0,27
ORO33020	ORO TRINGA 2XE14 B	5901752710283	2 x 10	300 x 100 x 175		0,54
ORO33021	ORO TRINGA 3XE14 B	5901752710290	3 x 10	320 x 320 x 175		0,93
ORO33022	ORO TRINGA 4XE14 B	5901752710306	4 x 10	740 x 100 x 175		1,03



EPSILON

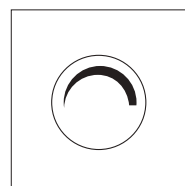
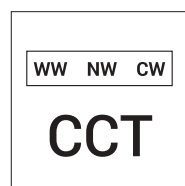

ORO33060

Index	Name	EAN	P _{on} [W]	Φ _{mod} [lm]	Φ _{360°} [lm]	CCT [K]	L x W x H [mm]		[kg]
ORO33061	ORO EPSILON LED B	5901752710696	14	1850	900	2700-4000-6500 	245 x 48 x 800		0,69
ORO33060	ORO EPSILON LED W	5901752710689	14	1850	900	2700-4000-6500 	245 x 48 x 800		0,69

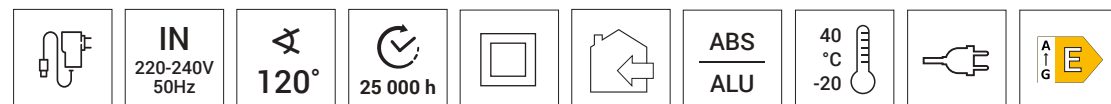

ORO33061

PICA

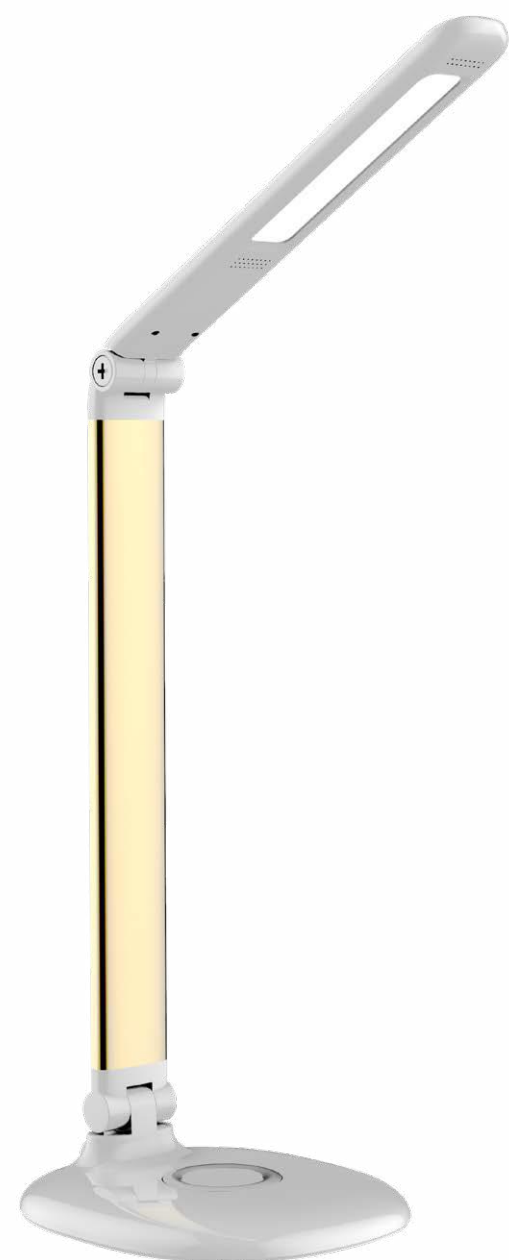
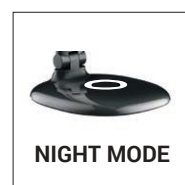
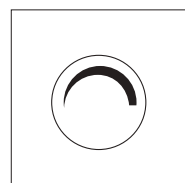
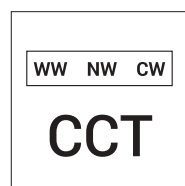

ORO33057

Index	Name	EAN	Pon [W]	Φmod [lm]	Φ360° [lm]	CCT [K]	L x W x H [mm]		[kg]
ORO33064	ORO PICA LED B/G	5901752710726	9	520	280	3000-4000-6000 	260 x 150 x 450		0,65
ORO33057	ORO PICA LED W/G	5901752710658	9	520	280	3000-4000-6000 	260 x 150 x 450		0,65

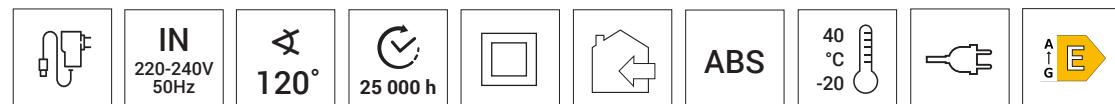



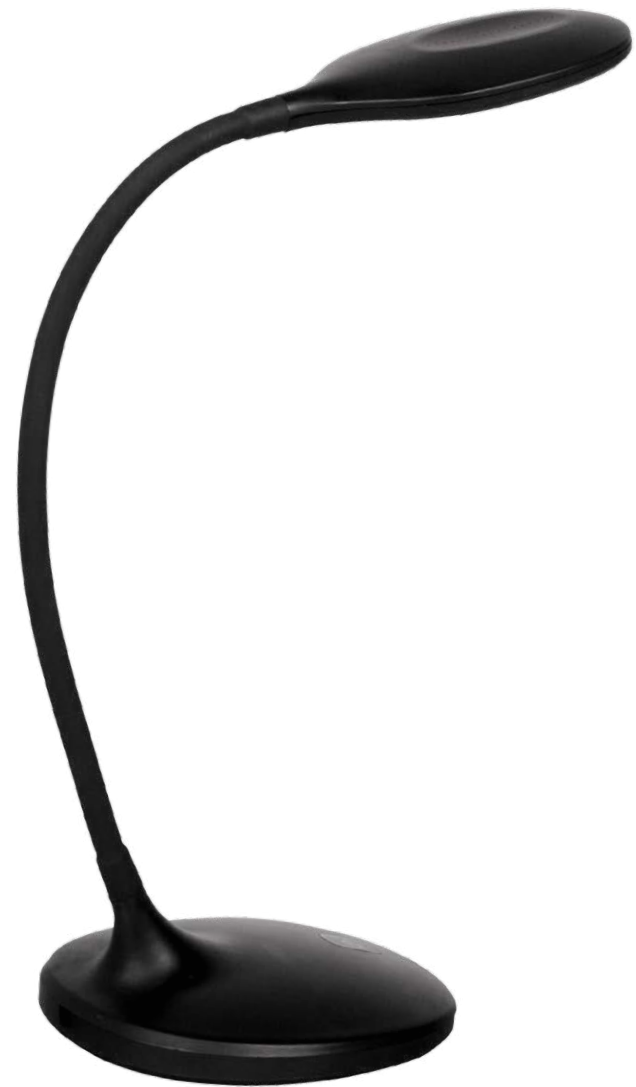
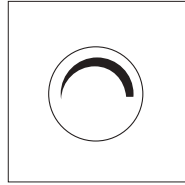

ORO33064

LETTA



ORO33053

Index	Name	EAN	Pon [W]	Φ360° [lm]	CCT [K]	L x W x H [mm]		 [kg]
ORO33053	ORO LETTA LED B	5901752710610	7	600	4000	190 x 190 x 400		1,58
ORO33052	ORO LETTA LED W	5901752710603	7	600	4000	190 x 190 x 400		1,58

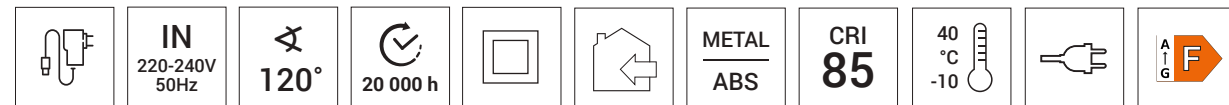

ORO33052

ORO33053

ADRI

WW NW CW
CCT

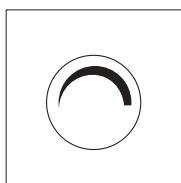

ORO33050

Index	Name	EAN	Pon [W]	Φmod [lm]	Φ360° [lm]	CCT [K]	L x W x H [mm]		[kg]
ORO33051	ORO ADRI LED B	5901752710597	6,5	470	310	3000-4000-6500	290 x 120 x 340		0,66
ORO33050	ORO ADRI LED W	5901752710580	6,5	470	310	3000-4000-6500	290 x 120 x 340		0,66

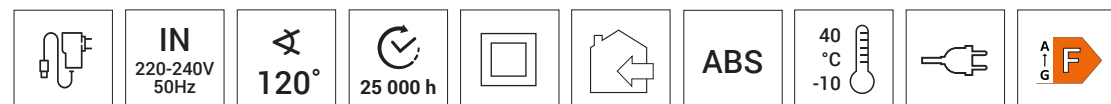

ORO33051

ORO33050

ANTILA

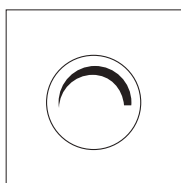
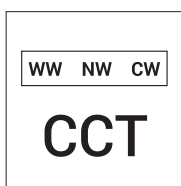

ORO33059

Index	Name	EAN	Pon [W]	Φ360° [lm]	Φuse [lm]	CCT [K]	L x W x H [mm]		[kg]
ORO33059	ORO ANTILA LED B	5901752710672	8	570	520 α 120°	2700-4000-6500 	340 x 150 x 450		0,64
ORO33058	ORO ANTILA LED W	5901752710665	8	570	520 α 120°	2700-4000-6500 	340 x 150 x 450		0,64

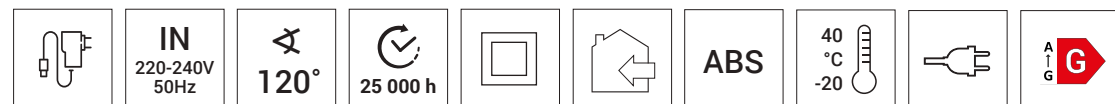

ORO33058

VERO

4
colours
of fixture



ORO33042



Index	Name	EAN	Pon [W]	Φ360° [lm]	CCT [K]	L x W x H [mm]		[kg]
ORO33042	ORO VERO LED W	5901752710504	4,5	405	3000	140 x 140 x 395		0,76
ORO33043	ORO VERO LED B	5901752710511	4,5	405	3000	140 x 140 x 395		0,76
ORO33044	ORO VERO LED BL	5901752710528	4,5	405	3000	140 x 140 x 395		0,76
ORO33045	ORO VERO LED P	5901752710535	4,5	405	3000	140 x 140 x 395		0,76



LARUS



ORO33049

Index	Name	EAN	Pon [W]	Φ360° [lm]	CCT [K]	L x W x H [mm]		
ORO33046	ORO LARUS CL LED W*	5901752710542	3	240	3000	100 x 60 x 400		0,32
ORO33047	ORO LARUS CL LED B*	5901752710559	3	240	3000	100 x 60 x 400		0,32
ORO33048	ORO LARUS LED W	5901752710566	3	240	3000	110 x 110 x 415		0,66
ORO33049	ORO LARUS LED B	5901752710573	3	240	3000	110 x 110 x 415		0,66

* Klips mocujący do blatu biurka / Desk top clip / Schreibtischclip

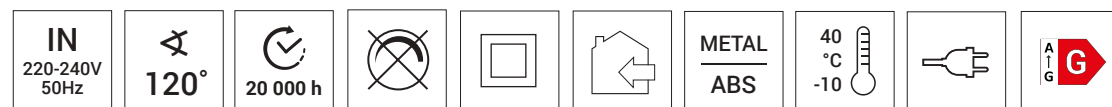

ALBA

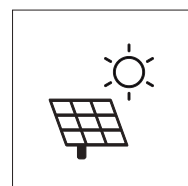
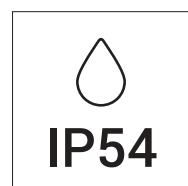

ORO10046

Index	Name	EAN	Pon [W]	Φ360° [lm]	α	CCT [K]	L x W x H [mm]		[kg]
ORO10046	ORO-ALBA-0,5W-1-CW ***	5902533197224	0,5	50	180°	6500	50 x 150 x 215		0,46
ORO10047	ORO-ALBA-2W-2-MIC-CW *	5902533197231	2	330	120°	6500	46 x 83 x 170		0,20
ORO10048	ORO-ALBA-6W-3-MIC-CW **	5902533197248	6	730	120°	6500	79 x 202 x 105		0,43
ORO10049	ORO-ALBA-6,5W-4-PIR-CW	5902533197255	6,5	630	120°	6500	165 x 170 x 45		0,46
ORO10050	ORO-ALBA-10W-5-PIR-CW ***	5902533197262	10	750	120°	6500	70 x 135 x 156 30 x 138 x 150		0,50

** * Lampa z mikrofalowym czujnikiem ruchu / Luminaire with microwave motion sensor



ORO10049



ORO10048



ORO10047



ORO10050

ZOE



ZOE 2



ZOE 3

Index	Name	EAN	Pmax [W]	L x W x H [mm]		
ORO10038	ORO-ZOE-2-GREY	5902533196784	10	91 x 303 x 101		0,33
ORO10039	ORO-ZOE-3-GREY	5902533196791	10	92 x 231 x 260		0,54



CUBE | SAN



CUBE



SAN

Index	Name	EAN	Pmax [W]	IP	L x W x H [mm]		
ORO10040	ORO-CUBE-E27-GREY	5902533196982	10	44	106 x 74 x 165		0,33
ORO10055	ORO-SAN-E27 *	5902533197316	10	54	155 x 88 x 165		0,20

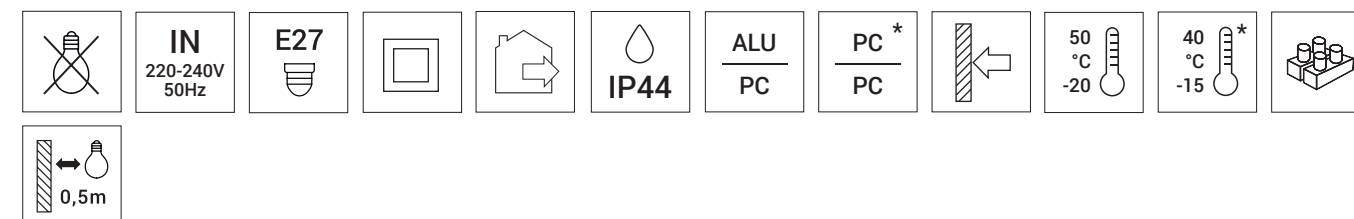

SPARK

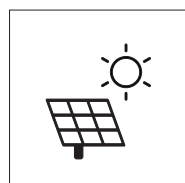
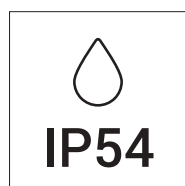

Index	Name	EAN	Pon [W]	Φ360° [lm]	CCT [K]	L x W x H [mm]		[kg]
ORO33175	ORO SPARK III	5905972140219	0,2	25	2000	∅ 80 x 650		0,23

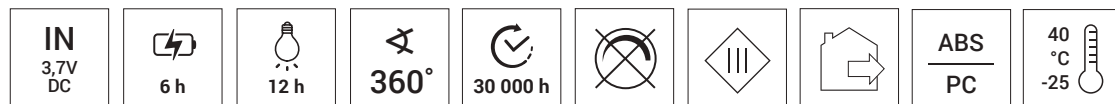

03

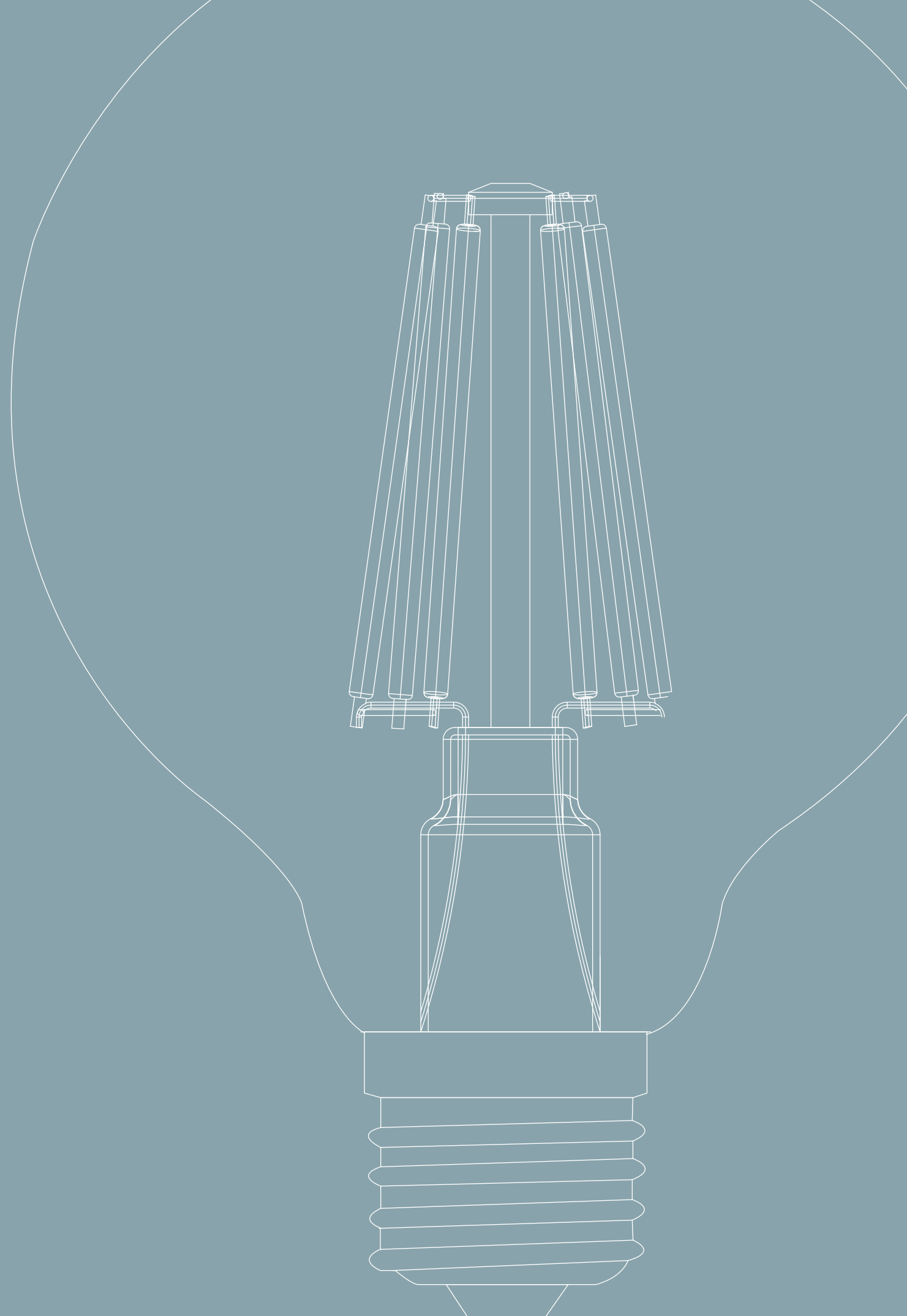
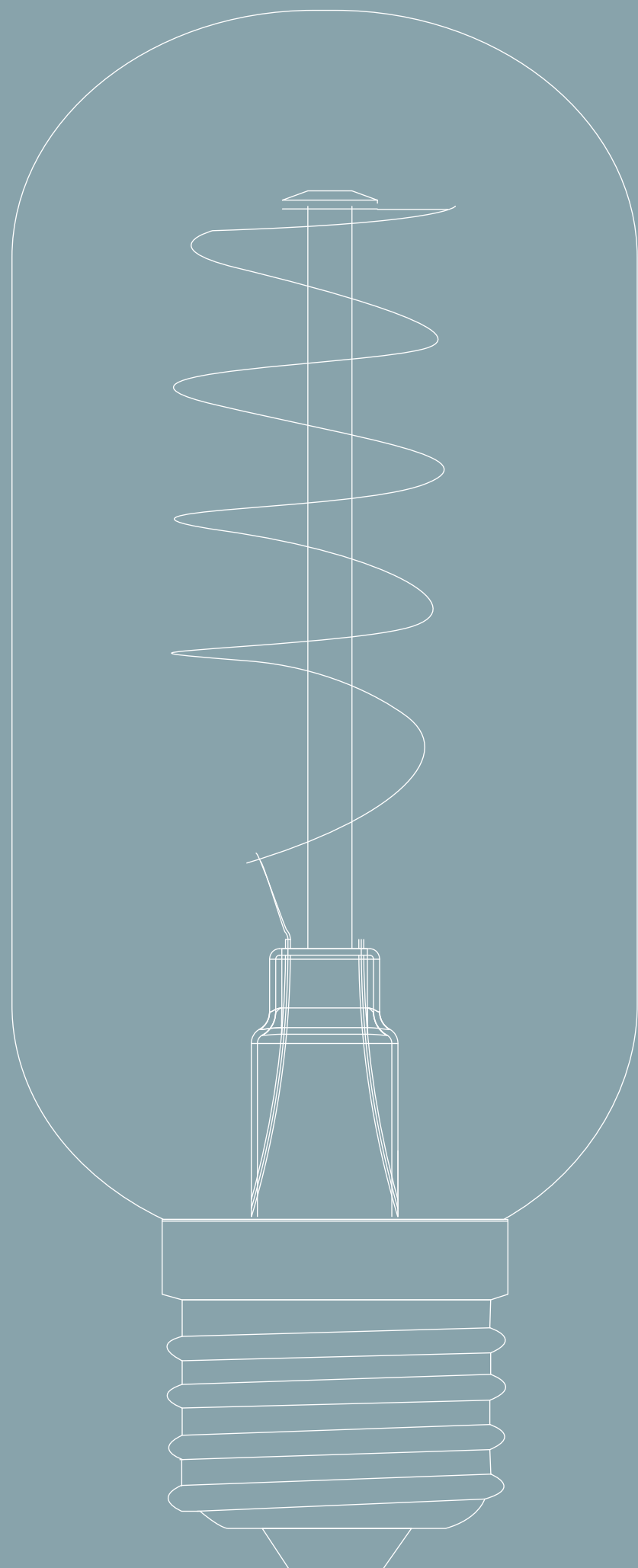

LIGHT SOURCES

ŹRÓDŁA ŚWIATŁA / SVĚTELNÉ ZDROJE /
SVETELNÉ ZDROJE

E27 WI-FI DRIVE

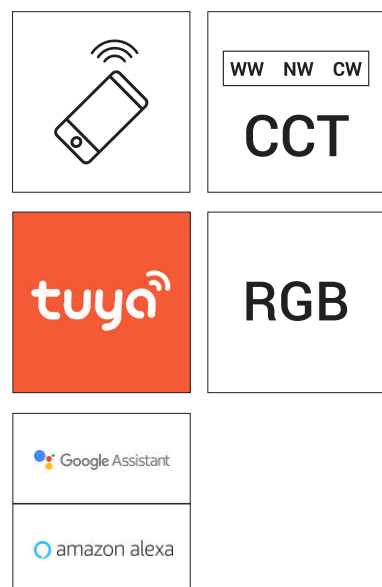

Index	Name	EAN	Pon [W]	= [W]	Φ360° [lm]	η [lm/W]	CCT [K]	L x W x H [mm]
ORO31002	ORO-E27-A65-WIFI-DRIVE-15W-RGBW *	5902533197408	15	94	1400	93	RGB+3000-6500	∅ 65 x 133
ORO31001	ORO-E27-A60-WIFI-DRIVE-9W-RGBW	5902533197392	9	60	806	90	RGB+3000-6500	∅ 60 x 118

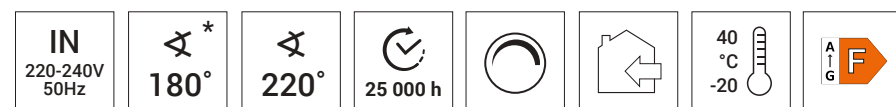

E27 RGBW



Index	Name	EAN	Pon [W]	= [W]	Φ360° [lm]	η [lm/W]	CCT [K]	L x W x H [mm]
ORO04112	ORO-E27-A60-6,5W-RGBW	5902533194391	6,5W	55W	520	80	RGB+4000	∅ 60 x 110



E27 PREMIUM

5
years
warranty



Index	Name	EAN	Pon [W]	= [W]	Φ360° [lm]	η [lm/W]	CCT [K]	L x W x H [mm]
ORO04123	ORO-PREMIUM-E27-A65-14W-XP-WW	5902533195732	14	109	1680	120	3000	∅ 65 x 132
ORO04124	ORO-PREMIUM-E27-A65-14W-XP-DW	5902533195749	14	109	1680	120	4000	∅ 65 x 132
ORO04125	ORO-PREMIUM-E27-A65-14W-XP-CW	5902533195756	14	109	1680	120	6500	∅ 65 x 132
ORO04120	ORO-PREMIUM-E27-A60-12W-XP-WW *	5902533195701	12	96	1440	120	3000	∅ 60 x 125
ORO04121	ORO-PREMIUM-E27-A60-12W-XP-DW *	5902533195718	12	96	1440	120	4000	∅ 60 x 125
ORO04122	ORO-PREMIUM-E27-A60-12W-XP-CW *	5902533195725	12	96	1440	120	6500	∅ 60 x 125
ORO04117	ORO-PREMIUM-E27-A60-10W-XP-WW	5902533195671	10	83	1200	120	3000	∅ 60 x 111
ORO04118	ORO-PREMIUM-E27-A60-10W-XP-DW	5902533195688	10	83	1200	120	4000	∅ 60 x 111
ORO04119	ORO-PREMIUM-E27-A60-10W-XP-CW	5902533195695	10	83	1200	120	6500	∅ 60 x 111



E27 ATOS DIMM

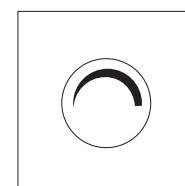

Index	Name	EAN	Pon [W]	= [W]	Φ360° [lm]	η [lm/W]	CCT [K]	L x W x H [mm]
ORO04178	ORO-ATOS-E27-A60-11W-WW-DIMM	5902533199693	11	75	1050	95	3000	∅ 60 x 118
ORO04179	ORO-ATOS-E27-A60-11W-DW-DIMM	5902533199709	11	75	1050	95	4000	∅ 60 x 118
ORO04180	ORO-ATOS-E27-A60-11W-CW-DIMM	5902533199716	11	75	1050	95	6500	∅ 60 x 118

- KONTAKT SIMON DS9L.01/11 + BMS9L.01/21
- OSPEL LP-8GL2/M/00

Žródła światła współpracują ze ściemniaczami przeznaczonymi do ściemniania źródeł LED zasilanych napięciem sieciowym 230V
Lighting sources cooperate with dimmers intended for dimming LED sources powered by 230V mains voltage

Světelné zdroje spolupracují se stmívači určenými ke stmívání LED zdrojů napájených síťovým napětím 230 V

Svetelné zdroje spolupracujú so stmievačom určeným na stmievanie LED zdrojov napájaných sieťovým napätím 230 V

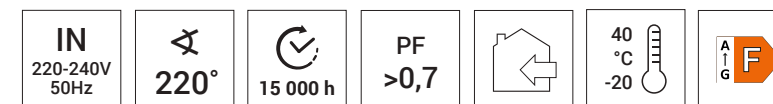

E27 ATOS



A55



A60



A65



A70

Index	Name	EAN	Pon [W]	= [W]	Φ360° [lm]	EEl	η [lm/W]	CCT [K]	L x W x H [mm]
OR004107	ORO-ATOS-E27-A70-19W-WW *	5902533194117	19	136	2200	E	116	3000	∅ 70 x 159
OR004108	ORO-ATOS-E27-A70-19W-DW *	5902533194124	19	136	2200	E	116	4000	∅ 70 x 159
OR004109	ORO-ATOS-E27-A70-19W-CW *	5902533194131	19	136	2200	E	116	6500	∅ 70 x 159
OR004104	ORO-ATOS-E27-A65-17W-WW *	5902533194087	17	120	1900	E	112	3000	∅ 65 x 138
OR004105	ORO-ATOS-E27-A65-17W-DW *	5902533194094	17	120	1900	E	112	4000	∅ 65 x 138
OR004106	ORO-ATOS-E27-A65-17W-CW *	5902533194100	17	120	1900	E	112	6500	∅ 65 x 138
OR004162	ORO-ATOS-E27-A60-12W-WW	5902533198405	12	100	1521	E	127	3000	∅ 60 x 112
OR004163	ORO-ATOS-E27-A60-12W-DW	5902533198412	12	100	1521	E	127	4000	∅ 60 x 112
OR004164	ORO-ATOS-E27-A60-12W-CW	5902533198429	12	100	1521	E	127	6500	∅ 60 x 112
OR004159	ORO-ATOS-E27-A60-10,5W-WW	5902533198375	10,5	86	1255	E	120	3000	∅ 60 x 112
OR004160	ORO-ATOS-E27-A60-10,5W-DW	5902533198382	10,5	86	1255	E	120	4000	∅ 60 x 112
OR004161	ORO-ATOS-E27-A60-10,5W-CW	5902533198399	10,5	86	1255	E	120	6500	∅ 60 x 112
OR004156	ORO-ATOS-E27-A60-8,5W-WW	5902533198344	8,5	75	1050	E	124	3000	∅ 60 x 108
OR004157	ORO-ATOS-E27-A60-8,5W-DW	5902533198351	8,5	75	1050	E	124	4000	∅ 60 x 108
OR004158	ORO-ATOS-E27-A60-8,5W-CW	5902533198368	8,5	75	1050	E	124	6500	∅ 60 x 108
OR004153	ORO-ATOS-E27-A60-7,5W-WW	5902533198313	7,5	60	806	F	107	3000	∅ 60 x 108
OR004154	ORO-ATOS-E27-A60-7,5W-DW	5902533198320	7,5	60	806	F	107	4000	∅ 60 x 108
OR004155	ORO-ATOS-E27-A60-7,5W-CW	5902533198337	7,5	60	806	F	107	6500	∅ 60 x 108
OR004150	ORO-ATOS-E27-A55-5W-WW	5902533198283	5	42	500	F	100	3000	∅ 55 x 102
OR004151	ORO-ATOS-E27-A55-5W-DW	5902533198290	5	42	500	F	100	4000	∅ 55 x 102
OR004152	ORO-ATOS-E27-A55-5W-CW	5902533198306	5	42	500	F	100	6500	∅ 55 x 102

IN 220-240V 50Hz
220°
240°
20 000 h
40 °C -20
AIG E
AIG F

E27 TOTO



G45



C37

Index	Name	EAN	Pon [W]	= [W]	Φ360° [lm]	EEI	η [lm/W]	CCT [K]	L x W x H [mm]
OR004168	ORO-E27-G45-TOTO-8W-WW	5902533198467	8	66	900	E	112	3000	∅ 45 x 80
OR004169	ORO-E27-G45-TOTO-8W-DW	5902533198474	8	66	900	E	112	4000	∅ 45 x 80
OR004170	ORO-E27-G45-TOTO-8W-CW	5902533198481	8	66	900	E	112	6500	∅ 45 x 80
OR004165	ORO-E27-C37-TOTO-8W-WW	5902533198436	8	66	900	E	112	3000	∅ 37 x 110
OR004166	ORO-E27-C37-TOTO-8W-DW	5902533198443	8	66	900	E	112	4000	∅ 37 x 110
OR004167	ORO-E27-C37-TOTO-8W-CW	5902533198450	8	66	900	E	112	6500	∅ 37 x 110
OR004171	ORO-E27-G45-TOTO-5W-WW *	5902533198719	5	42	500	F	100	3000	∅ 45 x 80
OR004172	ORO-E27-G45-TOTO-5W-DW *	5902533198726	5	42	500	F	100	4000	∅ 45 x 80
OR004173	ORO-E27-G45-TOTO-5W-CW *	5902533198733	5	42	500	F	100	6500	∅ 45 x 80



E14 PREMIUM

5
years
warranty



G45



C37

Index	Name	EAN	Pon [W]	= [W]	Φ360° [lm]	η [lm/W]	CCT [K]	L x W x H [mm]
OR003055	ORO-PREMIUM-E14-C37-7W-XP-WW	5902533195763	7	62	840	120	3000	∅ 37 x 106
OR003056	ORO-PREMIUM-E14-C37-7W-XP-DW	5902533195770	7	62	840	120	4000	∅ 37 x 106
OR003057	ORO-PREMIUM-E14-C37-7W-XP-CW	5902533195787	7	62	840	120	6500	∅ 37 x 106
OR003058	ORO-PREMIUM-E14-G45-7W-XP-WW	5902533195794	7	62	840	120	3000	∅ 47 x 88
OR003059	ORO-PREMIUM-E14-G45-7W-XP-DW	5902533195800	7	62	840	120	4000	∅ 47 x 88
OR003060	ORO-PREMIUM-E14-G45-7W-XP-CW	5902533195817	7	62	840	120	6500	∅ 47 x 88



E14 TOTO



G45



C37

Index	Name	EAN	Pon [W]	= [W]	Φ360° [lm]	EEI	η [lm/W]	CCT [K]	L x W x H [mm]
ORO03052	ORO-E14-G45-TOTO-8W-WW *	5902533194056	8	66	900	E	112	3000	∅ 45 x 80
ORO03053	ORO-E14-G45-TOTO-8W-DW *	5902533194063	8	66	900	E	112	4000	∅ 45 x 80
ORO03054	ORO-E14-G45-TOTO-8W-CW *	5902533194070	8	66	900	E	112	6500	∅ 45 x 80
ORO03049	ORO-E14-C37-TOTO-8W-WW *	5902533194025	8	66	900	E	112	3000	∅ 37 x 103
ORO03050	ORO-E14-C37-TOTO-8W-DW *	5902533194032	8	66	900	E	112	4000	∅ 37 x 103
ORO03051	ORO-E14-C37-TOTO-8W-CW *	5902533194049	8	66	900	E	112	6500	∅ 37 x 103
ORO03077	ORO-E14-G45-TOTO-5W-WW	5902533198580	5	42	500	F	100	3000	∅ 45 x 80
ORO03078	ORO-E14-G45-TOTO-5W-DW	5902533198597	5	42	500	F	100	4000	∅ 45 x 80
ORO03079	ORO-E14-G45-TOTO-5W-CW	5902533198603	5	42	500	F	100	6500	∅ 45 x 80
ORO03071	ORO-E14-C37-TOTO-5W-WW	5902533198528	5	42	500	F	100	3000	∅ 37 x 100
ORO03072	ORO-E14-C37-TOTO-5W-DW	5902533198535	5	42	500	F	100	4000	∅ 37 x 100
ORO03073	ORO-E14-C37-TOTO-5W-CW	5902533198542	5	42	500	F	100	6500	∅ 37 x 100
ORO03074	ORO-E14-G45-TOTO-3,5W-WW	5902533198559	3,5	25	249	G	71	3000	∅ 45 x 80
ORO03075	ORO-E14-G45-TOTO-3,5W-DW	5902533198566	3,5	25	249	G	71	4000	∅ 45 x 80
ORO03076	ORO-E14-G45-TOTO-3,5W-CW	5902533198573	3,5	25	249	G	71	6500	∅ 45 x 80
ORO03068	ORO-E14-C37-TOTO-3,5W-WW	5902533198498	3,5	25	249	G	71	3000	∅ 37 x 100
ORO03069	ORO-E14-C37-TOTO-3,5W-DW	5902533198504	3,5	25	249	G	71	4000	∅ 37 x 100
ORO03070	ORO-E14-C37-TOTO-3,5W-CW	5902533198511	3,5	25	249	G	71	6500	∅ 37 x 100



E14 R50



Index	Name	EAN	Pon [W]	Φ [W]	$\Phi 360^\circ$ [lm]	η [lm/W]	CCT [K]	L x W x H [mm]
ORO03080	ORO-E14-R50-5W-WW	5902533198689	5	42	500	100	3000	\varnothing 50 x 85
ORO03081	ORO-E14-R50-5W-DW	5902533198696	5	42	500	100	4000	\varnothing 50 x 85
ORO03082	ORO-E14-R50-5W-CW	5902533198702	5	42	500	100	6500	\varnothing 50 x 85



E14 T20



Index	Name	EAN	Pon [W]	Φ [W]	$\Phi 360^\circ$ [lm]	η [lm/W]	CCT [K]	L x W x H [mm]
ORO03030	ORO-E14-T20-1,8W-WW	5902533191758	1,8	14	130	72	3000	\varnothing 23 x 50
ORO33062	ORO-E14-T20-1,8W-CW	5901752710702	1,8	14	130	72	6500	\varnothing 23 x 50



E14 MINI



Index	Name	EAN	Pon [W]	= [W]	Φ360° [lm]	η [lm/W]	CCT [K]	L x W x H [mm]
ORO33065	ORO MINI E14 2,7W WW	5901752710733	2,7	28	300	111	3000	∅ 18 x 68
ORO33066	ORO MINI E14 2,7W NW	5901752710740	2,7	28	300	111	4000	∅ 18 x 68



E27 ULTRA

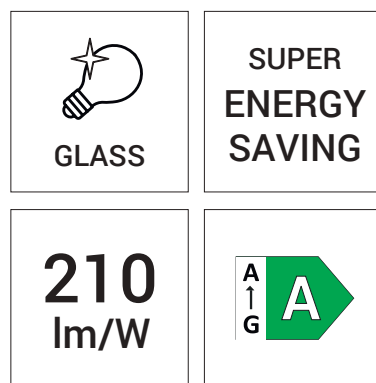

Index	Name	EAN	Pon [W]	= [W]	Φ360° [lm]	η [lm/W]	CCT [K]	L x W x H [mm]
ORO33176	ORO ULTRA FLT E27 A60 2,3W WW	5905972140226	2,3	41	485	210	3000	∅ 60 x 108
ORO33177	ORO ULTRA FLT E27 A60 2,3W NW	5905972140233	2,3	41	485	210	4000	∅ 60 x 108
ORO33178	ORO ULTRA FLT E27 A60 4W WW	5905972140240	4	62	840	210	3000	∅ 60 x 108
ORO33179	ORO ULTRA FLT E27 A60 4W NW	5905972140257	4	62	840	210	4000	∅ 60 x 108
ORO33180	ORO ULTRA FLT E27 A60 5W WW	5905972140264	5	75	1055	210	3000	∅ 60 x 108
ORO33181	ORO ULTRA FLT E27 A60 5W NW	5905972140271	5	75	1055	210	4000	∅ 60 x 108
ORO33182	ORO ULTRA FLT E27 A60 7,2W WW	5905972140288	7,2	100	1520	210	3000	∅ 60 x 108
ORO33183	ORO ULTRA FLT E27 A60 7,2W NW	5905972140295	7,2	100	1520	210	4000	∅ 60 x 108



E27 AMBER



Index	Name	EAN	Pon [W]	= [W]	Φ360° [lm]	EEI	η [lm/W]	CCT [K]	L x W x H [mm]
ORO04129	ORO-E27-G80-FL-AMBER-6W-DIMM-WW*	5902533196289	6	45	550	F	92	2200	∅ 80 x 124
ORO04029	ORO-E27-G125-FL-AMBER-6W-WW	5902533190614	6	45	550	F	92	2200	∅ 125 x 171
ORO04027	ORO-E27-ST64-FL-AMBER-4W-WW	5902533198443	4	33	360	F	90	2200	∅ 64 x 142
ORO04174	ORO-E27-ST64-FL-AMBER-1,3W-WW	5902533199259	1,3	8	55	G	42	2200	∅ 64 x 142

- KONTAKT SIMON DS9L.01/11 + BMS9L.01/21
- OSPEL LP-8GL2/M/00

Žródła światła współpracują ze ściemniaczami przeznaczonymi do ściemniania źródeł LED zasilanych napięciem sieciowym 230V

Lighting sources cooperate with dimmers intended for dimming LED sources powered by 230V mains voltage

Světelné zdroje spolupracují se stmívači určenými ke stmívání LED zdrojů napájených síťovým napětím 230 V

Svetelné zdroje spolupracujú so stmievačom určeným na stmievanie LED zdrojov napájaných sieťovým napätím 230 V

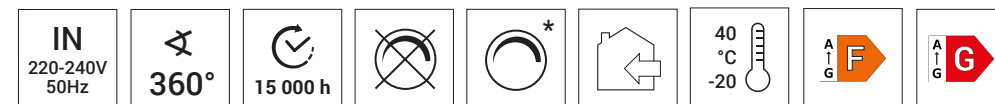

E27 CLARO



Index	Name	EAN	Pon [W]	= [W]	Φ360° [lm]	EEL	η [lm/W]	CCT [K]	L x W x H [mm]
OR004140	ORO-E27-A67-FL-CLARO-16W-WW	5902533190614	16	136	2200	D	137	2700	∅ 67 x 125
OR004143	ORO-E27-A67-FL-CLARO-16W-DW	5902533196289	16	136	2200	D	137	4000	∅ 67 x 125
OR004138	ORO-E27-A60-FL-CLARO-10,5W-WW	5902533196449	10,5	100	1521	D	145	2700	∅ 60 x 108
OR004141	ORO-E27-A60-FL-CLARO-10,5W-DW	5902533196470	10,5	100	1521	D	145	4000	∅ 60 x 108
OR004103	ORO-E27-FL-CLARO-8,2W-WW	5902533193929	8,2	78	1120	D	137	2700	∅ 60 x 108
OR004100	ORO-E27-FL-CLARO-7W-WW	5902533193349	7	60	808	E	115	2700	∅ 60 x 105
OR004130	ORO-E27-FL-CLARO-7W-DW	5902533196319	7	60	808	E	115	4000	∅ 60 x 105
OR004146	ORO-E27-C35-FL-CLARO-4W-WW	5902533196517	4	38	440	E	110	2700	∅ 35 x 98
OR004147	ORO-E27-C35-FL-CLARO-4W-DW	5902533196524	4	38	440	E	110	4000	∅ 35 x 98
OR004099	ORO-E27-G125-FL-CLARO-8W-WW	5902533193257	8	69	950	E	119	2700	∅ 125 x 171
OR004175	ORO-E27-ST64-FL-CLARO-8W-WW	5902533199266	8	75	1055	E	132	2700	∅ 64 x 142
OR004176	ORO-E27-ST64-FL-CLARO-8W-DW	5902533199273	8	75	1055	E	132	4000	∅ 64 x 142
OR004177	ORO-E27-G80-FL-CLARO-6W-DIMM-DW *	5902533199402	6	45	550	F	92	4000	∅ 80 x 124
OR004051	ORO-E27-G45-FL-CLARO-4W-WW	5902533192380	4	35	400	F	100	2700	∅ 45 x 78
OR004145	ORO-E27-G45-FL-CLARO-4W-DW	5902533196302	4	35	400	F	100	4000	∅ 45 x 78
OR004149	ORO-E27-G45-FL-CLARO-1,3W-WW	5902533196548	1,3	8	55	G	42	2700	∅ 45 x 78

- KONTAKT SIMON DS9L.01/11 + BMS9L.01/21
- OSPEL LP-8GL2/M/00

Žródła światła współpracują ze ściemniaczami przeznaczonymi do ściemniania źródeł LED zasilanych napięciem sieciowym 230V

Lighting sources cooperate with dimmers intended for dimming LED sources powered by 230V mains voltage

Světelné zdroje spolupracují se stmívači určenými ke stmívání LED zdrojů napájených síťovým napětím 230 V

Svetelné zdroje spolupracujú so stmievačom určeným na stmievanie LED zdrojov napájaných sieťovým napätím 230 V

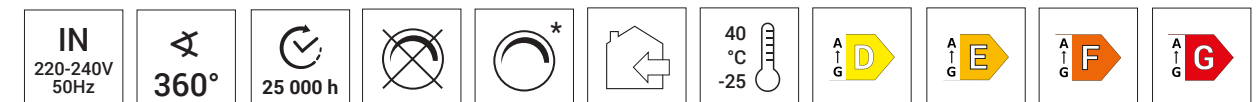

A60



C35

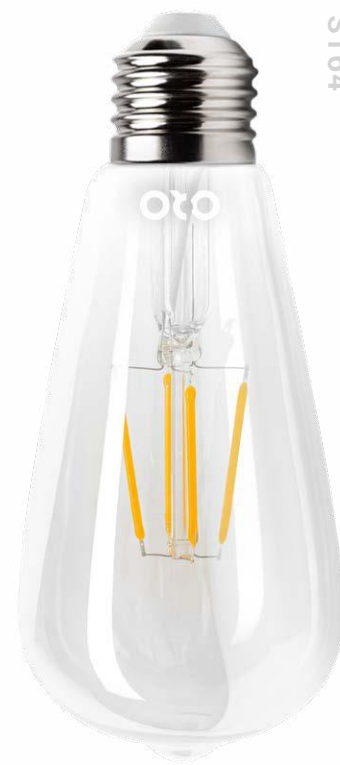

ST64



G45



A67



G125



G80

E14 CLARO



C35



C35 FLAMI

Index	Name	EAN	Pon [W]	= [W]	Φ360° [lm]	η [lm/W]	CCT [K]	L x W x H [mm]
ORO03018	ORO-E14-C35-FL-CLARO-4W-WW	5902533190577	4	38	440	110	2700	∅ 35 x 98
ORO03061	ORO-E14-C35-FL-CLARO-4W-DW	5902533196296	4	38	440	110	4000	∅ 35 x 98
ORO03062	ORO-E14-C35-FL-CLARO-6W-WW	5902533196333	6	60	806	134	2700	∅ 35 x 98
ORO03063	ORO-E14-C35-FL-CLARO-6W-DW	5902533196340	6	60	806	134	4000	∅ 35 x 98
ORO03065	ORO-E14-C35-FL-CLARO-FLAMI-6W-WW	5902533196364	6	60	806	134	2700	∅ 35 x 118
ORO03066	ORO-E14-C35-FL-CLARO-FLAMI-6W-DW	5902533196371	6	60	806	134	4000	∅ 35 x 118
ORO03019	ORO-E14-C35-FL-CLARO-FLAMI-4W-WW	5902533190584	4	38	440	110	2700	∅ 35 x 118
ORO03067	ORO-E14-C35-FL-CLARO-FLAMI-4W-DW	5902533196555	4	38	440	110	4000	∅ 35 x 118



E14 ROTO



Index	Name	EAN	Pon [W]	= [W]	Φ360° [lm]	η [lm/W]	CCT [K]	L x W x H [mm]
ORO03064	ORO-E14-C35-FL-ROTO-6W-WW	5902533196357	6	57	750	125	2700	∅ 35 x 98



GU10 PREMIUM

5
years
warranty



Index	Name	EAN	Pon [W]	= [W]	Φ360° [lm]	Φuse [lm]	η [lm/W]	CCT [K]	L x W x H [mm]
ORO01052	ORO-PREMIUM-GU10-7W-XP-WW	5902533195824	7	65	720	616 \ltimes 120°	88	3000	∅ 50 x 57
ORO01053	ORO-PREMIUM-GU10-7W-XP-DW	5902533195831	7	65	720	616 \ltimes 120°	88	4000	∅ 50 x 57
ORO01054	ORO-PREMIUM-GU10-7W-XP-CW	5902533195848	7	65	720	616 \ltimes 120°	88	6500	∅ 50 x 57



GU10 ATOS DIMM

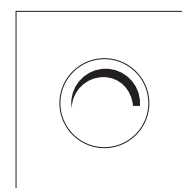

Index	Name	EAN	Pon [W]	= [W]	Φ360° [lm]	Φuse [lm]	η [lm/W]	CCT [K]	L x W x H [mm]
ORO01065	ORO-ATOS-GU10-5W-WW-DIMM	5902533195886	5	41	450	365 \ltimes 120°	73	3000	∅ 50 x 56
ORO01066	ORO-ATOS-GU10-5W-DW-DIMM	5902533195893	5	41	450	365 \ltimes 120°	73	4000	∅ 50 x 56
ORO01067	ORO-ATOS-GU10-5W-CW-DIMM	5902533195909	5	41	450	365 \ltimes 120°	73	6500	∅ 50 x 56

- KONTAKT SIMON DS9L.01/11 + BMS9L.01/21
- OSPEL LP-8GL2/M/00

Žródła światła współpracują ze ściemniaczami przeznaczonymi do ściemniania źródeł LED zasilanych napięciem sieciowym 230V
Lighting sources cooperate with dimmers intended for dimming LED sources powered by 230V mains voltage

Světelné zdroje spolupracují se stmívači určenými ke stmívání LED zdrojů napájených síťovým napětím 230 V

Svetelné zdroje spolupracujú so stmievačom určeným na stmievanie LED zdrojov napájaných sieťovým napätím 230 V

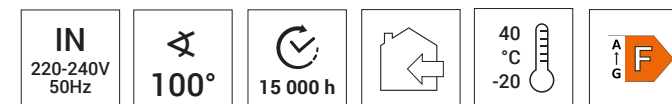

GU10 LUPO



Index	Name	EAN	Pon [W]	= [W]	Φ360° [lm]	Φuse [lm]	η [lm/W]	CCT [K]	L x W x H [mm]
ORO01050	ORO-GU10-LUPO-7W-WW-II	5902533194537	7	48	560	510 \sphericalangle 90°	73	3000	∅ 50 x 55
ORO01042	ORO-GU10-LUPO-7W-DW-II	5902533193677	7	48	560	510 \sphericalangle 90°	73	4000	∅ 50 x 55
ORO01051	ORO-GU10-LUPO-7W-CW-II	5902533194544	7	48	560	510 \sphericalangle 90°	73	6500	∅ 50 x 55



GU10 HERA



Index	Name	EAN	Pon [W]	= [W]	Φ360° [lm]	Φuse [lm]	η [lm/W]	CCT [K]	L x W x H [mm]
ORO01041	ORO-GU10-HERA-8W-II-WW	5901549640588	8	72	850	680 \sphericalangle 120°	85	3000	∅ 50 x 55
ORO01013	ORO-GU10-HERA-8W-II-DW	5902533190119	8	72	850	680 \sphericalangle 120°	85	4000	∅ 50 x 55
ORO01017	ORO-GU10-HERA-8W-II-CW	5901549640595	8	72	850	680 \sphericalangle 120°	85	6500	∅ 50 x 55



GU10 TOTO



TOTO



TOTO BLACK

Index	Name	EAN	Pon [W]	= [W]	Φ360° [lm]	Φuse [lm]	EEL	η [lm/W]	CCT [K]	L x W x H [mm]
ORO01062	ORO-GU10-TOTO-6,5W-WW	5902533198658	6,5	47	530	430 \times 120°	G	66	3000	∅ 50 x 55
ORO01063	ORO-GU10-TOTO-6,5W-DW	5902533198665	6,5	47	530	430 \times 120°	G	66	4000	∅ 50 x 55
ORO01064	ORO-GU10-TOTO-6,5W-CW	5902533198672	6,5	47	530	430 \times 120°	G	66	6500	∅ 50 x 55
ORO33146	ORO-GU10-TOTO-BLACK-6,5W-WW	5902533196005	6,5	51	650	520 \times 120°	F	80	3000	∅ 50 x 55
ORO33147	ORO-GU10-TOTO-BLACK-6,5W-DW	5902533196012	6,5	51	650	520 \times 120°	F	80	4000	∅ 50 x 55
ORO01059	ORO-GU10-TOTO-5W-WW	5902533198627	5	37	410	330 \times 120°	G	66	3000	∅ 50 x 55
ORO01060	ORO-GU10-TOTO-5W-DW	5902533198634	5	37	410	330 \times 120°	G	66	4000	∅ 50 x 55
ORO01061	ORO-GU10-TOTO-5W-CW	5902533198641	5	37	410	330 \times 120°	G	66	6500	∅ 50 x 55
ORO01001	ORO-GU10-TOTO-3W-WW	5901752711389	3	26	250	200 \times 120°	G	67	3000	∅ 50 x 55
ORO01058	ORO-GU10-TOTO-3W-DW	5902533198610	3	26	250	200 \times 120°	G	67	4000	∅ 50 x 55
ORO01002	ORO-GU10-TOTO-3W-CW	5901752711396	3	26	250	200 \times 120°	G	67	6500	∅ 50 x 55

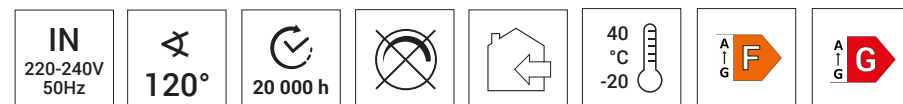

GU10 WI-FI DRIVE

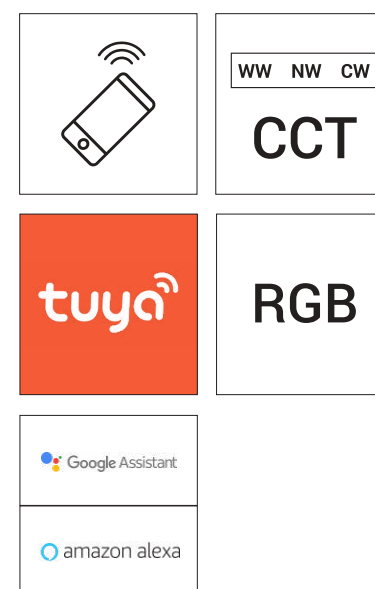

Index	Name	EAN	Pon [W]	= [W]	Φ360° [lm]	Φuse [lm]	η [lm/W]	CCT [K]	L x W x H [mm]
ORO31003	ORO-GU10-WIFI-DRIVE-5,5W-RGBW	5902533197415	5,5	39	400	352 \times 120°	64	RGB+3000-6500K	∅ 50 x 56



GU10 COLOR



Index	Name	EAN	P _{on} [W]	= [W]	Φ360° [lm]	Φuse [lm]	η [lm/W]	CCT [K]	L x W x H [mm]
ORO01048	ORO-GU10-SMD-BLUE	5902533193899	1	12	60	50 ± 120°	50	BLUE	∅ 50 x 55
ORO01048	ORO-GU10-SMD-GREEN	5902533193905	1	12	60	50 ± 120°	50	GREEN	∅ 50 x 55
ORO01047	ORO-GU10-SMD-RED	5902533193882	1	12	60	50 ± 120°	50	RED	∅ 50 x 55



GU10 D35



Index	Name	EAN	P _{on} [W]	= [W]	Φ360° [lm]	Φuse [lm]	η [lm/W]	CCT [K]	L x W x H [mm]
ORO01044	ORO-GU10-D35-1,8W-WW	5902533193691	1,8	19	170	130 ± 120°	72	3000	∅ 35 x 46
ORO01045	ORO-GU10-D35-1,8W-DW	5902533193707	1,8	19	170	130 ± 120°	72	4000	∅ 35 x 46
ORO01046	ORO-GU10-D35-1,8W-CW	5902533193714	1,8	19	170	130 ± 120°	72	6500	∅ 35 x 46



MR16



Index	Name	EAN	Pon [W]	= [W]	Φ360° [lm]	Φuse [lm]	η [lm/W]	CCT [K]	L x W x H [mm]
ORO29002	ORO-MR16-SIX-6W-WW	5901752712164	6	45	500	410 \times 120°	68	3000	∅ 50 x 55
ORO29007	ORO-MR16-SIX-6W-DW	5902533193721	6	45	500	410 \times 120°	68	4000	∅ 50 x 55
ORO29001	ORO-MR16-SIX-6W-CW	5901752712157	6	45	500	410 \times 120°	68	6500	∅ 50 x 55
ORO29008	ORO-MR16-4W-WW	5902533194209	4	27	250	210 \times 120°	52	3000	∅ 50 x 52
ORO29009	ORO-MR16-4W-DW	5902533194216	4	27	250	210 \times 120°	52	4000	∅ 50 x 52
ORO29010	ORO-MR16-4W-CW	5902533194223	4	27	250	210 \times 120°	52	6500	∅ 50 x 52



MR11



Index	Name	EAN	Pon [W]	= [W]	Φ360° [lm]	Φuse [lm]	η [lm/W]	CCT [K]	L x W x H [mm]
ORO02003	ORO-MR11-1,8W-WW	5902533193745	1,8W	19W	150	130 \times 120°	72	3000	∅ 35 x 40
ORO02004	ORO-MR11-1,8W-DW	5902533193752	1,8W	19W	150	130 \times 120°	72	4000	∅ 35 x 40
ORO02005	ORO-MR11-1,8W-CW	5902533193769	1,8W	19W	150	130 \times 120°	72	6500	∅ 35 x 40



G9 PREMIUM

5
years
warranty



Index	Name	EAN	Pon [W]	= [W]	Φ360° [lm]	η [lm/W]	CCT [K]	L x W x H [mm]
ORO05021	ORO-G9-PREMIUM-4W-WW	5902533197460	4	40	470	117	3000	∅ 14 x 56
ORO05022	ORO-G9-PREMIUM-4W-DW	5902533197477	4	40	470	117	4000	∅ 14 x 56
ORO05023	ORO-G9-PREMIUM-4W-CW	5902533197484	4	40	470	117	6500	∅ 14 x 56



G9 PETIT



Index	Name	EAN	Pon [W]	= [W]	Φ360° [lm]	η [lm/W]	CCT [K]	L x W x H [mm]
ORO05024	ORO-G9-PETIT-4,8W-WW	5902533197491	4,8	50	630	131	3000	∅ 14 x 56
ORO05025	ORO-G9-PETIT-4,8W-DW	5902533197507	4,8	50	630	131	4000	∅ 14 x 56
ORO05026	ORO-G9-PETIT-4,8W-CW	5902533197514	4,8	50	630	131	6500	∅ 14 x 56



G9 SEDI | OLI



SEDI



OLI

Index	Name	EAN	Pon [W]	= [W]	Φ360° [lm]	η [lm/W]	CCT [K]	L x W x H [mm]
ORO05030	ORO-G9-SEDI-4W-WW-II	5902533197705	4	40	470	117	3000	∅ 19 x 56
ORO05031	ORO-G9-SEDI-4W-DW-II	5902533197712	4	40	470	117	4000	∅ 19 x 56
ORO05032	ORO-G9-SEDI-4W-CW-II	5902533197729	4	40	470	117	6500	∅ 19 x 56
ORO05033	ORO-G9-OLI-3W-WW-II	5902533198252	3	32	350	117	3000	∅ 16 x 50
ORO05034	ORO-G9-OLI-3W-DW-II	5902533198269	3	32	350	117	4000	∅ 16 x 50
ORO05035	ORO-G9-OLI-3W-CW-II	5902533198276	3	32	350	117	6500	∅ 16 x 50



G4



G4



OLI

Index	Name	EAN	Pon [W]	= [W]	Φ360° [lm]	η [lm/W]	CCT [K]	L x W x H [mm]
ORO24001	ORO-G4-1,5W-WW	5902533191727	1,5	15	140	93	3000	20 x 30 x 5
ORO24002	ORO-G4-1,5W-CW	5902533191734	1,5	15	140	93	6500	20 x 30 x 5
ORO24006	ORO-G4-OLI-1W-WW *	5901752712737	1	11	100	100	3000	∅ 10 x 35

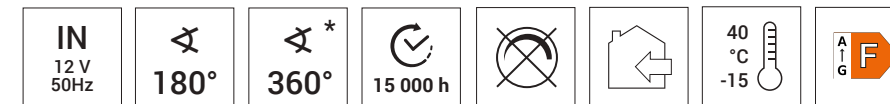

T8 GLASS POWER

5
years
warranty

150
lm/W



Index	Name	EAN	Pon [W]	Φ360° [lm]	η [lm/W]	CCT [K]	L x W x H [mm]
ORO17039	ORO-GLASS-POWER-T8-60-9W-DW	5902533196135	9	1350	150	4000	∅ 26 x 588
ORO17040	ORO-GLASS-POWER-T8-60-9W-CW	5902533196142	9	1350	150	6500	∅ 26 x 588
ORO17023	ORO-GLASS-POWER-T8-120-18W-DW	5902533194681	18	2700	150	4000	∅ 26 x 1198
ORO17024	ORO-GLASS-POWER-T8-120-18W-CW	5902533194698	18	2700	150	6500	∅ 26 x 1198
ORO17025	ORO-GLASS-POWER-T8-150-24W-DW	5902533194704	24	3600	150	4000	∅ 26 x 1500
ORO17026	ORO-GLASS-POWER-T8-150-24W-CW	5902533194711	24	3600	150	6500	∅ 26 x 1500

IN 220-240V 50Hz
300°
50 000 h
⊗
⏪
45 °C -20
AIG D



T8 GLASS

3
years
warranty



Index	Name	EAN	Pon [W]	Φ360° [lm]	η [lm/W]	CCT [K]	L x W x H [mm]
ORO17035	ORO-T8-60-GLASS-DW-II	5902533195213	9	1125	125	4000	∅ 26 x 588
ORO17034	ORO-T8-60-GLASS-CW-II	5902533195206	9	1125	125	6500	∅ 26 x 588
ORO17037	ORO-T8-120-GLASS-DW-II	5902533195237	18	2250	125	4000	∅ 26 x 1198
ORO17036	ORO-T8-120-GLASS-CW-II	5902533195220	18	2250	125	6500	∅ 26 x 1198
ORO17038	ORO-T8-150-GLASS-DW-II	5902533195244	24	3000	125	4000	∅ 26 x 1500
ORO17033	ORO-T8-150-GLASS-CW-II	5902533195190	24	3000	125	6500	∅ 26 x 1500



T8 BASIC

Index	Name	EAN	Pon [W]	Φ360° [lm]	η [lm/W]	CCT [K]	L x W x H [mm]
ORO17041	ORO-T8-60-BASIC-9W-DW-III	5902533199198	9	900	100	4000	∅ 26 x 600
ORO17042	ORO-T8-60-BASIC-9W-CW-III	5902533199204	9	900	100	6500	∅ 26 x 600
ORO17043	ORO-T8-120-BASIC-18W-DW-III	5902533199211	18	1825	100	4000	∅ 26 x 1200
ORO17044	ORO-T8-120-BASIC-18W-CW-III	5902533199228	18	1825	100	6500	∅ 26 x 1200
ORO17046	ORO-T8-150-BASIC-22W-DW-III	5902533199242	22	2250	100	4000	∅ 26 x 1500
ORO17045	ORO-T8-150-BASIC-22W-CW-III	5902533199235	22	2250	100	6500	∅ 26 x 1500



LCOB SET

3
years
warranty

CRI>
95

1 x TAŠMA LED LED STRIP LED PÁSEK LED PÁS + 1 x ZASILACZ SUPPLY ZDROJ NAPÁJENÍ ZDROJ + 1 x PILOT REMOTE DÁLKOVÝ OVLÁDAČ DIALKOVÝ OVLÁDAČ + 1 x STEROWNIK CONTROLLER OVLADAČ OVLÁDAČ

Index	Name	EAN	P [W/m]	Φ120° [lm/m]	η [lm/W]	IP	CCT [K]	L x W x H [mm]
ORO09085	ORO-STRIP-320L-LCOB-NWD-DW-SET	5902533199501	7,8	820	105	00	4000	5000 x 8 x 2

25 mm

IN
220-240V
50Hz

STRIP
12V
DC

120°

320/m

20 000 h

40 °C
-25

F

LCOB

3
years
warranty

CRI>
90

Index	Name	EAN	P [W/m]	Φ120° [lm/m]	η [lm/W]	IP	CCT [K]	L x W x H [mm]
ORO09082	ORO-STRIP-320L-LCOB-2835-NWD-WW-8MM	5902533199327	8,7	870	100	00	3000	5000 x 8 x 2
ORO09083	ORO-STRIP-320L-LCOB-2835-NWD-DW-8MM	5902533199334	8,7	870	100	00	4000	5000 x 8 x 2
ORO09084	ORO-STRIP-320L-LCOB-2835-NWD-CW-8MM	5902533199341	8,7	870	100	00	6500	5000 x 8 x 2

25 mm

STRIP
12V
DC

120°

320/m

15 000 h

40 °C
-20

F



WI-FI DRIVE SET

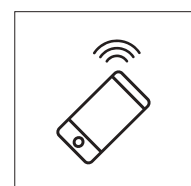

3

years
warranty



WW NW CW

CCT

Google Assistant

amazon alexa



CCT SET

3

years
warranty



Index	Name	EAN	P [W/m]	Φ120° [lm/m]	IP	CCT [K]	L x W x H [mm]
ORO31004	ORO-STRIP-5050-NWD-WIFI-DRIVE-RGBW-SET	5902533197422	6,6	500	00	RGB+3000-6500K	3000 x 10 x 2

Index	Name	EAN	P [W/m]	Φ120° [lm/m]	η [lm/W]	IP	CCT [K]	L x W x H [mm]
ORO09086	ORO-STRIP-600L-SMD-NWD-CCT-SET	5902533199518	5	500	100	00	3000-6500	5000 x 10 x 2



- + 1 x TAŠMA LED LED STRIP
LED PÁSEK LED PÁS
- + 1 x ZASILACZ SUPPLY
ZDROJ NAPÁJENÍ ZDROJ
- + 1 x PILOT REMOTE DÁLKOVÝ
OVLÁDAČ DIALKOVÝ OVLÁDAČ
- + 1 x STEROWNIK CONTROLLER
OVLÁDAČ OVLÁDAČ



- + 1 x TAŠMA LED LED STRIP
LED PÁSEK LED PÁS
- + 1 x ZASILACZ SUPPLY
ZDROJ NAPÁJENÍ ZDROJ
- + 1 x PILOT REMOTE DÁLKOVÝ
OVLÁDAČ DIALKOVÝ OVLÁDAČ
- + 1 x STEROWNIK CONTROLLER
OVLÁDAČ OVLÁDAČ

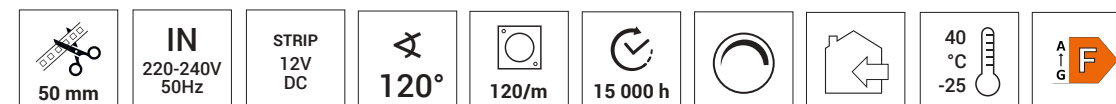
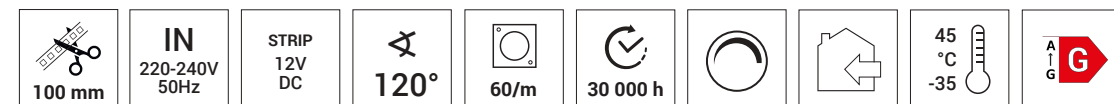

RGBW SET

WW NW CW

CCT



14W/m

IP64*



Index	Name	EAN	P [W/m]	Φ120° [lm/m]	IP	CCT [K]	L x W x H [mm]
ORO09062	ORO-STRIP-300L-RGBW-NWD-SET	5902533194407	12	180	00	RGB+4000K	5000 x 10 x 2



- + 1 x TAŠMA LED LED STRIP
LED PÁSEK LED PÁS
- + 1 x ZASILACZ SUPPLY
ZDROJ NAPÁJENÍ ZDROJ
- + 1 x PILOT REMOTE DÁLKOVÝ
OVLÁDAČ DIALKOVÝ OVLÁDAČ
- + 1 x STEROWNIK CONTROLLER
OVLADAČ OVLÁDAČ

Index	Name	EAN	P [W/m]	Φ120° [lm/m]	η [lm/W]	IP	CCT [K]	L x W x H [mm]
ORO09053	ORO-STRIP-600L-SMD-2835-WD-WW-8MM	5901752719590	14,4	1470	102	64 *	3000	5000 x 8 x 3
ORO33136	ORO-STRIP-600L-SMD-2835-WD-DW-8MM	5902533192403	14,4	1470	102	64 *	4000	5000 x 8 x 3
ORO09055	ORO-STRIP-600L-SMD-2835-WD-CW-8MM	5901752719903	14,4	1470	102	64 *	6500	5000 x 8 x 3
ORO09052	ORO-STRIP-600L-SMD-2835-NWD-WW-8MM	5901752719583	14,4	1470	102	00	3000	5000 x 8 x 3
ORO09058	ORO-STRIP-600L-SMD-2835-NWD-DW-8MM	5902533193516	14,4	1470	102	00	4000	5000 x 8 x 3
ORO09054	ORO-STRIP-600L-SMD-2835-NWD-CW-8MM	5901752719897	14,4	1470	102	00	6500	5000 x 8 x 3

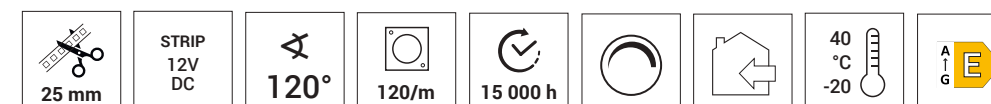
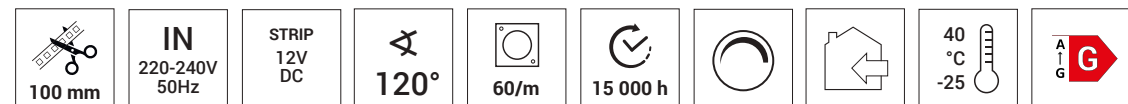

10W/m



Index	Name	EAN	P [W/m]	Φ120° [lm/m]	η [lm/W]	IP	CCT [K]	L x W x H [mm]
ORO09008	ORO-STRIP-300L-SMD-5630-WD-WW	5901549640120	10,8	1160	107	64 *	3000	5000 x 10 x 2
ORO33134	ORO-STRIP-300L-SMD-5630-WD-DW	5902533190980	10,8	1160	107	64 *	4000	5000 x 10 x 2
ORO09009	ORO-STRIP-300L-SMD-5630-WD-CW	5901549640137	10,8	1160	107	64 *	6500	5000 x 10 x 2
ORO09051	ORO-STRIP-300L-SMD-5630-NWD-WW	5901752719576	10,8	1160	107	00	3000	5000 x 10 x 2
ORO09003	ORO-STRIP-300L-SMD-5630-NWD-DW	5901752718876	10,8	1160	107	00	4000	5000 x 10 x 2
ORO09050	ORO-STRIP-300L-SMD-5630-NWD-CW	5901752719569	10,8	1160	107	00	6500	5000 x 10 x 2



8W/m

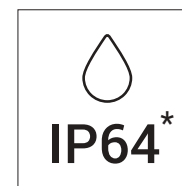

Index	Name	EAN	P [W/m]	Φ120° [lm/m]	η [lm/W]	IP	CCT [K]	L x W x H [mm]
ORO09056	ORO-STRIP-300L-SMD-2835-WD-WW-8MM	5901752719965	8,4	870	104	64 *	3000	5000 x 8 x 2
ORO33135	ORO-STRIP-300L-SMD-2835-WD-DW-8MM	5902533191925	8,4	870	104	64 *	4000	5000 x 8 x 2
ORO09010	ORO-STRIP-300L-SMD-2835-WD-CW-8MM	5901752710085	8,4	870	104	64 *	6500	5000 x 8 x 2
ORO09012	ORO-STRIP-300L-SMD-2835-NWD-WW-8MM	5901752712096	8,4	870	104	00	3000	5000 x 8 x 2
ORO09057	ORO-STRIP-300L-SMD-2835-NWD-DW-8MM	5902533193509	8,4	870	104	00	4000	5000 x 8 x 2
ORO09011	ORO-STRIP-300L-SMD-2835-NWD-CW-8MM	5901752712072	8,4	870	104	00	6500	5000 x 8 x 2



14W/m 50m



Index	Name	EAN	P [W/m]	Φ120° [lm/m]	η [lm/W]	IP	CCT [K]	L x W x H [mm]
ORO09079	ORO-STRIP-SMD-2835-120L-NWD-WW-8MM-50M	5902533196043	14,4	1470	102	00	3000	50 000 x 8 x 2
ORO09080	ORO-STRIP-SMD-2835-120L-NWD-DW-8MM-50M	5902533196050	14,4	1470	102	00	4000	50 000 x 8 x 2
ORO09081	ORO-STRIP-SMD-2835-120L-NWD-CW-8MM-50M	5902533196067	14,4	1470	102	00	6500	50 000 x 8 x 2



8W/m 50m



Index	Name	EAN	P [W/m]	Φ120° [lm/m]	η [lm/W]	IP	CCT [K]	L x W x H [mm]
ORO09059	ORO-STRIP-SMD-2835-NWD-WW-8MM-50M	5902533193608	8,4	870	104	00	3000	50 000 x 8 x 2
ORO09060	ORO-STRIP-SMD-2835-NWD-DW-8MM-50M	5902533193615	8,4	870	104	00	4000	50 000 x 8 x 2
ORO09061	ORO-STRIP-SMD-2835-NWD-CW-8MM-50M	5902533193622	8,4	870	104	00	6500	50 000 x 8 x 2



HIGH CRI

3
years
warranty

CRI >
95



Index	Name	EAN	P [W/m]	Φ120° [lm/m]	η [lm/W]	IP	CCT [K]	L x W x H [mm]
ORO09076	ORO-STRIP-600L-2835-NWD-HIGH-CRI-DW	5902533195428	15,3	1400	92	00	4000	5000 x 8 x 2
ORO09077	ORO-STRIP-600L-2835-NWD-HIGH-CRI-CW	5902533195435	15,3	1400	92	00	6500	5000 x 8 x 2

25 mm

STRIP
12V
DC

120°

120/m

50 000 h

45 °C
-20

WW-CW

3
years
warranty



Index	Name	EAN	P [W/m]	Φ120° [lm/m]	η [lm/W]	IP	CCT [K]	L x W x H [mm]
ORO09078	ORO-STRIP-600L-2835-NWD-WW-CW	5902533195534	15,3	1650	108	00	3000-4000 -6500	5000 x 10 x 2

50 mm

STRIP
12V
DC

120°

120/m

50 000 h

45 °C
-20

RGB



Index	Name	EAN	P [W/m]	Φ120° [lm/m]	IP	CCT [K]	L x W x H [mm]
ORO09030	ORO-STRIP-300L-SMD-RGB-NWD-BP	5901752715394	10,8	330	00	RGB	5000 x 10 x 2
ORO09033	ORO-STRIP-300L-SMD-RGB-WD-BP*	5901752715554	10,8	330	64*	RGB	5000 x 10 x 3
ORO09031	ORO-STRIP-150L-SMD-RGB-NWD-BP	5901752715400	6	85	00	RGB	5000 x 8 x 2
ORO09032	ORO-STRIP-150L-SMD-RGB-WD-BP*	5901752715530	6	85	64*	RGB	5000 x 8 x 3

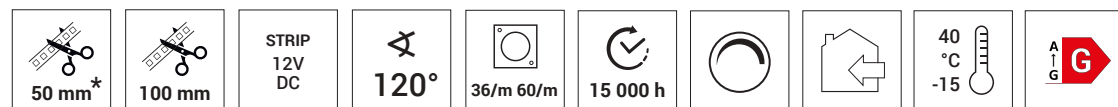

COLOR



Index	Name	EAN	P [W/m]	Φ120° [lm/m]	IP	CCT [K]	L x W x H [mm]
ORO09019	ORO-STRIP-300L-SMD-WD-NB-BP-8mm*	5901752715127	8,4	90	64*	BLUE	5000 x 8 x 3
ORO09021	ORO-STRIP-300L-SMD-WD-ZL-BP-8mm*	5901752715158	8,4	90	64*	GREEN	5000 x 8 x 3
ORO09070	ORO-STRIP-600L-2835-NWD-LEMON-YELLOW	5902533195367	13,1	90	00	YELLOW	5000 x 10 x 2
ORO09071	ORO-STRIP-600L-2835-NWD-VIOLET	5902533195374	13,1	90	00	VIOLET	5000 x 10 x 2
ORO09073	ORO-STRIP-600L-2835-NWD-GRASS-GREEN	5902533195398	13,1	90	00	GREEN	5000 x 10 x 2
ORO09074	ORO-STRIP-600L-2835-NWD-BRIGHT-PINK	5902533195404	13,1	90	00	PINK	5000 x 10 x 2

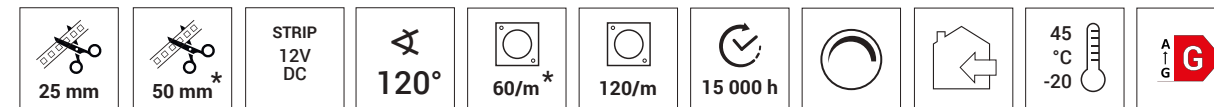

CONTROLLER

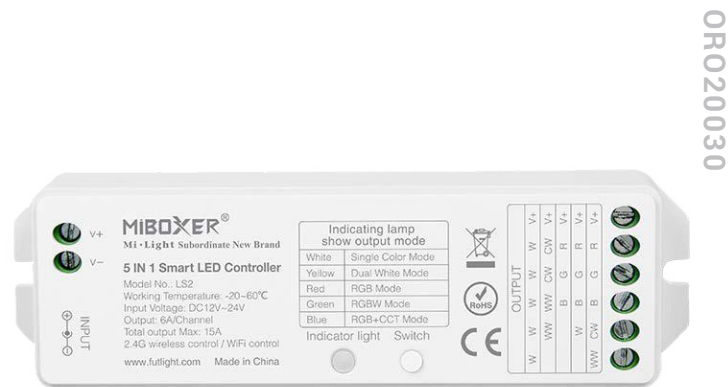

Index	Name	EAN	DCin [V]	Pmax [W]	I _{max} [A]	L x W x H [mm]
ORO20030	LS CONTROLLER 5IN1 *	5902533199945	12 24	180 (12V) 360 (24V)	15 / 6	124 x 38 x 23
ORO20028	ORO-REMOTE-DUAL-WHITE-4-ZONE *	5902533197361	-	-	-	111 x 53 x 21
ORO20026	ORO-REMOTE-RGBW-4-ZONE *	5902533195985	-	-	-	123 x 53 x 21

* Produkt kompatybilny Product compatible Produkt kompatibilní Produkt kompatibilný

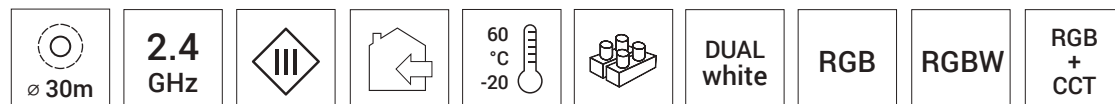

CONTROLLER



Index	Name	EAN	DCin [V]	Pmax [W]	I _{max} [A]	L x W x H [mm]
ORO20009	ORO-STEROWNNIK-RGB-1 *	5901752716506	12 24	72	6 (12V) 3 (24V)	50 x 35 x 22 84 x 52 x 7
ORO20029	ORO-WZMACNIACZ-RGBW	5902533197378	12 24	144	12 (12V) 6 (24V)	83 x 64 x 24

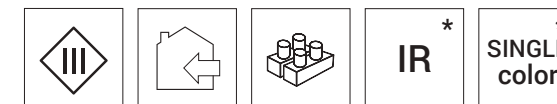

PROFIL SET UNI OUT

- + 1 x PROFIL UNI OUT UNI OUT PROFILE
PROFIL UNI OUT UNI OUT PROFIL
- + 2 x ZAŠLEPKA CAP POKRÝT KRYT
- + 1 x KLOSZ SLIDE/CLICK COVER SLIDE/CLICK
ODSTÍN SLIDE/CLICK KRYT SLIDE/CLICK



SLIDE

Index	Name	EAN	L x W x H [mm]		
ORO32021	ORO-PROFIL-UNI-OUT-1M-S-SET	5902533198009	1000 x 17 x 8,6	Aluminium / Aluminum / Hliník / Hliník	
ORO32022	ORO-PROFIL-UNI-OUT-2M-S-SET	5902533198016	2000 x 17 x 8,6	Aluminium / Aluminum / Hliník / Hliník	
ORO32027	ORO-PROFIL-UNI-OUT-WHITE-1M-S-SET	5902533198061	1000 x 17 x 8,6	Aluminium lakierowane / Lacquered aluminium / Lakovaný hliník / Lakovaný hliník	
ORO32028	ORO-PROFIL-UNI-OUT-WHITE-2M-S-SET	5902533198078	2000 x 17 x 8,6	Aluminium lakierowane / Lacquered aluminium / Lakovaný hliník / Lakovaný hliník	
ORO32033	ORO-PROFIL-UNI-OUT-BLACK-1M-S-SET	5902533198122	1000 x 17 x 8,6	Aluminium lakierowane / Lacquered aluminium / Lakovaný hliník / Lakovaný hliník	
ORO32034	ORO-PROFIL-UNI-OUT-BLACK-2M-S-SET	5902533198139	2000 x 17 x 8,6	Aluminium lakierowane / Lacquered aluminium / Lakovaný hliník / Lakovaný hliník	



CLICK

Index	Name	EAN	L x W x H [mm]		
ORO32039	ORO-PROFIL-UNI-OUT-2M-C-SET	5902533198184	2000 x 17 x 8,6	Aluminium / Aluminum / Hliník / Hliník	
ORO32042	ORO-PROFIL-UNI-OUT-WHITE-2M-C-SET	5902533198214	2000 x 17 x 8,6	Aluminium lakierowane / Lacquered aluminium / Lakovaný hliník / Lakovaný hliník	
ORO32045	ORO-PROFIL-UNI-OUT-BLACK-2M-C-SET	5902533198245	2000 x 17 x 8,6	Aluminium lakierowane / Lacquered aluminium / Lakovaný hliník / Lakovaný hliník	

PROFIL SET UNI IN

- + 1 x PROFIL UNI IN UNI IN PROFILE
PROFIL UNI IN UNI IN PROFIL
- + 2 x ZAŠLEPKA CAP POKRÝT KRYT
- + 1 x KLOSZ SLIDE/CLICK COVER SLIDE/CLICK
ODSTÍN SLIDE/CLICK KRYT SLIDE/CLICK



SLIDE

Index	Name	EAN	L x W x H [mm]		
ORO32019	ORO-PROFIL-UNI-IN-1M-S-SET	5902533197989	1000 x 27 x 8,6	Aluminium / Aluminum / Hliník / Hliník	
ORO32020	ORO-PROFIL-UNI-IN-2M-S-SET	5902533197996	2000 x 27 x 8,6	Aluminium / Aluminum / Hliník / Hliník	
ORO32025	ORO-PROFIL-UNI-IN-WHITE-1M-S-SET	5902533198047	1000 x 27 x 8,6	Aluminium lakierowane / Lacquered aluminium / Lakovaný hliník / Lakovaný hliník	
ORO32026	ORO-PROFIL-UNI-IN-WHITE-2M-S-SET	5902533198054	2000 x 27 x 8,6	Aluminium lakierowane / Lacquered aluminium / Lakovaný hliník / Lakovaný hliník	
ORO32031	ORO-PROFIL-UNI-IN-BLACK-1M-S-SET	5902533198108	1000 x 27 x 8,6	Aluminium lakierowane / Lacquered aluminium / Lakovaný hliník / Lakovaný hliník	
ORO32032	ORO-PROFIL-UNI-IN-BLACK-2M-S-SET	5902533198115	2000 x 27 x 8,6	Aluminium lakierowane / Lacquered aluminium / Lakovaný hliník / Lakovaný hliník	



CLICK

Index	Name	EAN	L x W x H [mm]		
ORO32038	ORO-PROFIL-UNI-IN-2M-C-SET	5902533198177	2000 x 27 x 8,6	Aluminium / Aluminum / Hliník / Hliník	
ORO32041	ORO-PROFIL-UNI-IN-WHITE-2M-C-SET	5902533198207	2000 x 27 x 8,6	Aluminium lakierowane / Lacquered aluminium / Lakovaný hliník / Lakovaný hliník	
ORO32044	ORO-PROFIL-UNI-IN-BLACK-2M-C-SET	5902533198238	2000 x 27 x 8,6	Aluminium lakierowane / Lacquered aluminium / Lakovaný hliník / Lakovaný hliník	

PROFIL SET UNI COR

- + 1 x PROFIL UNI COR UNI COR PROFILE
PROFIL UNI COR UNI COR PROFIL
- + 2 x ZAŠLEPKA CAP POKRÝT KRYT
- + 1 x KLOSZ SLIDE/CLICK COVER SLIDE/CLICK
ODSTÍN SLIDE/CLICK KRYT SLIDE/CLICK



SLIDE

Index	Name	EAN	L x W x H [mm]		
ORO32017	ORO-PROFIL-UNI-COR-1M-S-SET	5902533197965	1000 x 25,2 x 19,7	Aluminium / Aluminum / Hliník / Hliník	■
ORO32018	ORO-PROFIL-UNI-COR-2M-S-SET	5902533197972	2000 x 25,2 x 19,7	Aluminium / Aluminum / Hliník / Hliník	■
ORO32023	ORO-PROFIL-UNI-COR-WHITE-1M-S-SET	5902533198023	1000 x 25,2 x 19,7	Aluminium lakierowane / Lacquered aluminium / Lakovaný hliník / Lakovaný hliník	□
ORO32024	ORO-PROFIL-UNI-COR-WHITE-2M-S-SET	5902533198030	2000 x 25,2 x 19,7	Aluminium lakierowane / Lacquered aluminium / Lakovaný hliník / Lakovaný hliník	□
ORO32029	ORO-PROFIL-UNI-COR-BLACK-1M-S-SET	5902533198085	1000 x 25,2 x 19,7	Aluminium lakierowane / Lacquered aluminium / Lakovaný hliník / Lakovaný hliník	■
ORO32030	ORO-PROFIL-UNI-COR-BLACK-2M-S-SET	5902533198092	2000 x 25,2 x 19,7	Aluminium lakierowane / Lacquered aluminium / Lakovaný hliník / Lakovaný hliník	■



CLICK

Index	Name	EAN	L x W x H [mm]		
ORO32037	ORO-PROFIL-UNI-COR-2M-C-SET	5902533198160	2000 x 25,2 x 19,7	Aluminium / Aluminum / Hliník / Hliník	■
ORO32040	ORO-PROFIL-UNI-COR-WHITE-2M-C-SET	5902533198191	2000 x 25,2 x 19,7	Aluminium lakierowane / Lacquered aluminium / Lakovaný hliník / Lakovaný hliník	□
ORO32043	ORO-PROFIL-UNI-COR-BLACK-2M-C-SET	5902533198221	2000 x 25,2 x 19,7	Aluminium lakierowane / Lacquered aluminium / Lakovaný hliník / Lakovaný hliník	■

PROFIL

	Index	Name	EAN	L x W x H [mm]		
	ORO11001	ORO-PROFIL-UNI-IN-1M	5901752715967	1000 x 27 x 8,6	Aluminium anodowane / Anodized aluminium / Eloxovaný hliník / Eloxovaný hliník	■
	ORO11002	ORO-PROFIL-UNI-IN-2M	5901752715974	2000 x 27 x 8,6	Aluminium anodowane / Anodized aluminium / Eloxovaný hliník / Eloxovaný hliník	■
	ORO11076	ORO-PROFIL-UNI-IN-WHITE-1M	5902533196715	1000 x 27 x 8,6	Aluminium lakierowane / Lacquered aluminium / Lakovaný hliník / Lakovaný hliník	□
	ORO11077	ORO-PROFIL-UNI-IN-WHITE-2M	5902533196722	2000 x 27 x 8,6	Aluminium lakierowane / Lacquered aluminium / Lakovaný hliník / Lakovaný hliník	□
	ORO11078	ORO-PROFIL-UNI-IN-BLACK-1M	5902533196739	1000 x 27 x 8,6	Aluminium lakierowane / Lacquered aluminium / Lakovaný hliník / Lakovaný hliník	■
	ORO11079	ORO-PROFIL-UNI-IN-BLACK-2M	5902533196746	2000 x 27 x 8,6	Aluminium lakierowane / Lacquered aluminium / Lakovaný hliník / Lakovaný hliník	■
	ORO11093	ORO-PROFIL-UNI-IN-NAT-1M	5902533197545	1000 x 27 x 8,6	Aluminium	■
	ORO11094	ORO-PROFIL-UNI-IN-NAT-2M	5902533197552	2000 x 27 x 8,6	Aluminium	■
		ORO11003	ORO-PROFIL-UNI-OUT-1M	5901752715981	1000 x 17 x 8,6	Aluminium anodowane / Anodized aluminium / Eloxovaný hliník / Eloxovaný hliník
ORO11004		ORO-PROFIL-UNI-OUT-2M	5901752715998	2000 x 17 x 8,6	Aluminium anodowane / Anodized aluminium / Eloxovaný hliník / Eloxovaný hliník	■
ORO11072		ORO-PROFIL-UNI-OUT-WHITE-1M	5902533196678	1000 x 17 x 8,6	Aluminium lakierowane / Lacquered aluminium / Lakovaný hliník / Lakovaný hliník	□
ORO11073		ORO-PROFIL-UNI-OUT-WHITE-2M	5902533196685	2000 x 17 x 8,6	Aluminium lakierowane / Lacquered aluminium / Lakovaný hliník / Lakovaný hliník	□
ORO11074		ORO-PROFIL-UNI-OUT-BLACK-1M	5902533196692	1000 x 17 x 8,6	Aluminium lakierowane / Lacquered aluminium / Lakovaný hliník / Lakovaný hliník	■
ORO11075		ORO-PROFIL-UNI-OUT-BLACK-2M	5902533196708	2000 x 17 x 8,6	Aluminium lakierowane / Lacquered aluminium / Lakovaný hliník / Lakovaný hliník	■
ORO11091		ORO-PROFIL-UNI-OUT-NAT-1M	5902533197521	1000 x 17 x 8,6	Aluminium	■
ORO11092		ORO-PROFIL-UNI-OUT-NAT-2M	5902533197538	2000 x 17 x 8,6	Aluminium	■
		ORO11005	ORO-PROFIL-UNI-COR-1M	5901752716025	1000 x 25,2 x 19,7	Aluminium anodowane / Anodized aluminium / Eloxovaný hliník / Eloxovaný hliník
	ORO11006	ORO-PROFIL-UNI-COR-2M	5901752715639	2000 x 25,2 x 19,7	Aluminium anodowane / Anodized aluminium / Eloxovaný hliník / Eloxovaný hliník	■
	ORO11068	ORO-PROFIL-UNI-COR-WHITE-1M	5902533196630	1000 x 25,2 x 19,7	Aluminium lakierowane / Lacquered aluminium / Lakovaný hliník / Lakovaný hliník	□
	ORO11069	ORO-PROFIL-UNI-COR-WHITE-2M	5902533196647	2000 x 25,2 x 19,7	Aluminium lakierowane / Lacquered aluminium / Lakovaný hliník / Lakovaný hliník	□
	ORO11070	ORO-PROFIL-UNI-COR-BLACK-1M	5902533196654	1000 x 25,2 x 19,7	Aluminium lakierowane / Lacquered aluminium / Lakovaný hliník / Lakovaný hliník	■
	ORO11071	ORO-PROFIL-UNI-COR-BLACK-2M	5902533196661	2000 x 25,2 x 19,7	Aluminium lakierowane / Lacquered aluminium / Lakovaný hliník / Lakovaný hliník	■
	ORO11095	ORO-PROFIL-UNI-COR-NAT-1M	5902533197569	1000 x 25,2 x 19,7	Aluminium	■
	ORO11096	ORO-PROFIL-UNI-COR-NAT-2M	5902533197576	2000 x 25,2 x 19,7	Aluminium	■

Profile przeznaczone dla taśm o szerokości do 10 mm / Profiles dedicated for strips up to 10 mm wide
 Profily určené pro pásy do šířky 10 mm / Profily určené pre pásy do šírky 10 mm

COVER

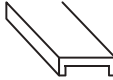
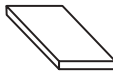



















	Index	Name	EAN	L x W x H [mm]	
	ORO11011	ORO-COVER-CLICK-1M	5901752718913	1000 x 15 x 5,5	PMMA
	ORO11012	ORO-COVER-CLICK-2M	5901752718920	2000 x 15 x 5,5	PMMA
	ORO11013	ORO-COVER-SLIDE-1M	5901752718937	1000 x 15 x 1,2	PS
	ORO11014	ORO-COVER-SLIDE-2M	5901752718944	2000 x 15 x 1,2	PS

CAP

	Index	Name	EAN		
	ORO11007	ORO-CAP-UNI-IN/OUT	5901752716476	PS	
	ORO11008	ORO-CAP-UNI-IN/OUT-O	5901752716483	PS	
	ORO11010	ORO-CAP-UNI-COR-L	5901752716698	PS	
	ORO11009	ORO-CAP-UNI-COR-R	5901752716681	PS	
	ORO11085	ORO-CAP-UNI-IN/OUT-WHITE	5902533196920	PS	
	ORO11086	ORO-CAP-UNI-IN/OUT-O-WHITE	5902533196937	PS	
	ORO11083	ORO-CAP-UNI-COR-L-WHITE	5902533196906	PS	
	ORO11084	ORO-CAP-UNI-COR-R-WHITE	5902533196913	PS	
	ORO11089	ORO-CAP-UNI-IN/OUT-BLACK	5902533196968	PS	
	ORO11090	ORO-CAP-UNI-IN/OUT-O-BLACK	5902533196975	PS	
	ORO11087	ORO-CAP-UNI-COR-L-BLACK	5902533196944	PS	
	ORO11088	ORO-CAP-UNI-COR-R-BLACK	5902533196951	PS	



CONNECT

	Index	Name	EAN	
	ORO28008	ORO-CONNECT1-8mm	5901752716957	Konektory przeznaczone dla pasków o białej barwie światła Connectors designed for strips with white light color Konektory určené pro pásy s bílou barvou světla Konektory určené pre pásiky s bielou farbou svetla
	ORO28009	ORO-CONNECT1-10mm	5901752716964	
	ORO28001	ORO-CONNECT2-10mm	5901752715882	
	ORO28002	ORO-CONNECT2-8mm	5901752715899	
	ORO28006	ORO-CONNECT3-8mm	5901752716933	
	ORO28007	ORO-CONNECT3-10mm	5901752716940	
	ORO28016	ORO-CONNECT1-CCT	5902533196104	
	ORO28017	ORO-CONNECT2-CCT	5902533196111	
	ORO28018	ORO-CONNECT3-CCT	5902533196128	
	ORO28012	ORO-CONNECT4-RGB	5901752719736	Konektory przeznaczone dla pasków RGB oraz RGBW Connectors designed for RGB strips and RGBW Konektory určené pro RGB a RGBW pásy Konektory určené pre RGB a RGBW pásiky
	ORO28010	ORO-CONNECT5-RGB	5901752716971	
	ORO28011	ORO-CONNECT6-RGB	5901752716988	
	ORO28013	ORO-CONNECT4-RGBW	5902533196074	
	ORO28014	ORO-CONNECT5-RGBW	5902533196081	
	ORO28015	ORO-CONNECT6-RGBW	5902533196098	
	ORO28019	ORO-CONNECT1-LCOB-8mm	5902533199525	
	ORO28020	ORO-CONNECT2-LCOB-8mm	5902533199532	Konektory przeznaczone dla pasków LCOB Connectors designed for LCOB strips Konektory určené pro LCOB pásy Konektory určené pre LCOB pásiky
	ORO28023	ORO-CONNECT3-LCOB-8mm	5902533199563	
	ORO28021	ORO-CONNECT-L-LCOB-8mm	5902533199549	
	ORO28022	ORO-CONNECT-T-LCOB-8mm	5902533199556	



	Index	Name	EAN
	ORO28027	ORO-CONNECT-X-8mm	5902533199600
	ORO28028	ORO-CONNECT-X-10mm	5902533199617
	ORO28029	ORO-CONNECT-X-RGB	5902533199624
	ORO28024	ORO-CONNECT-L-8mm	5902533199570
	ORO28025	ORO-CONNECT-L-10mm	5902533199587
	ORO28026	ORO-CONNECT-L-RGB	5902533199594
	ORO28030	ORO-CONNECT-T-8mm	5902533199631
	ORO28031	ORO-CONNECT-T-10mm	5902533199648
	ORO28032	ORO-CONNECT-T-RGB	5902533199655

IN
12V
DC

Imax
4A

IN
12V
DC

Imax
4A

04

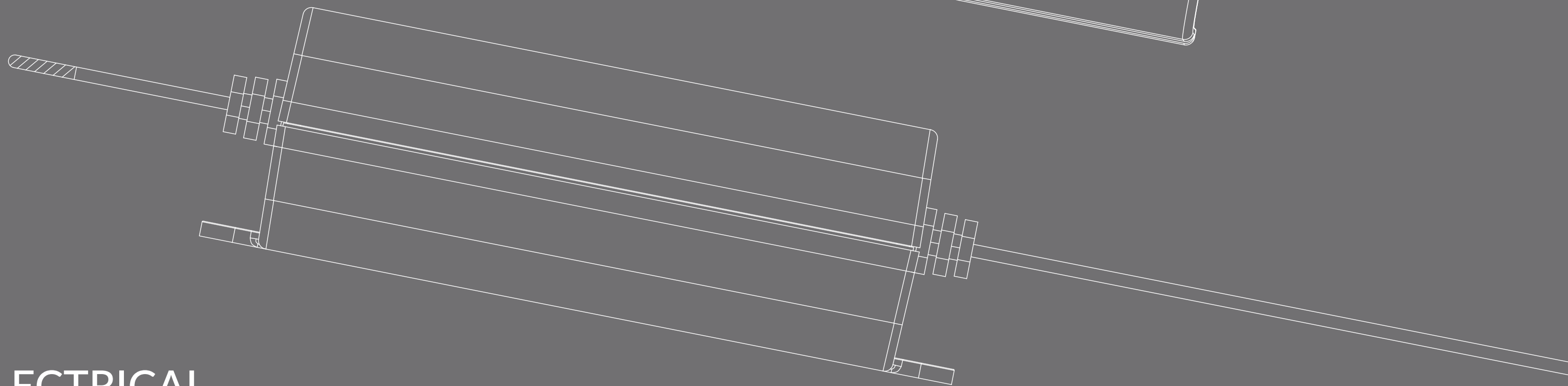
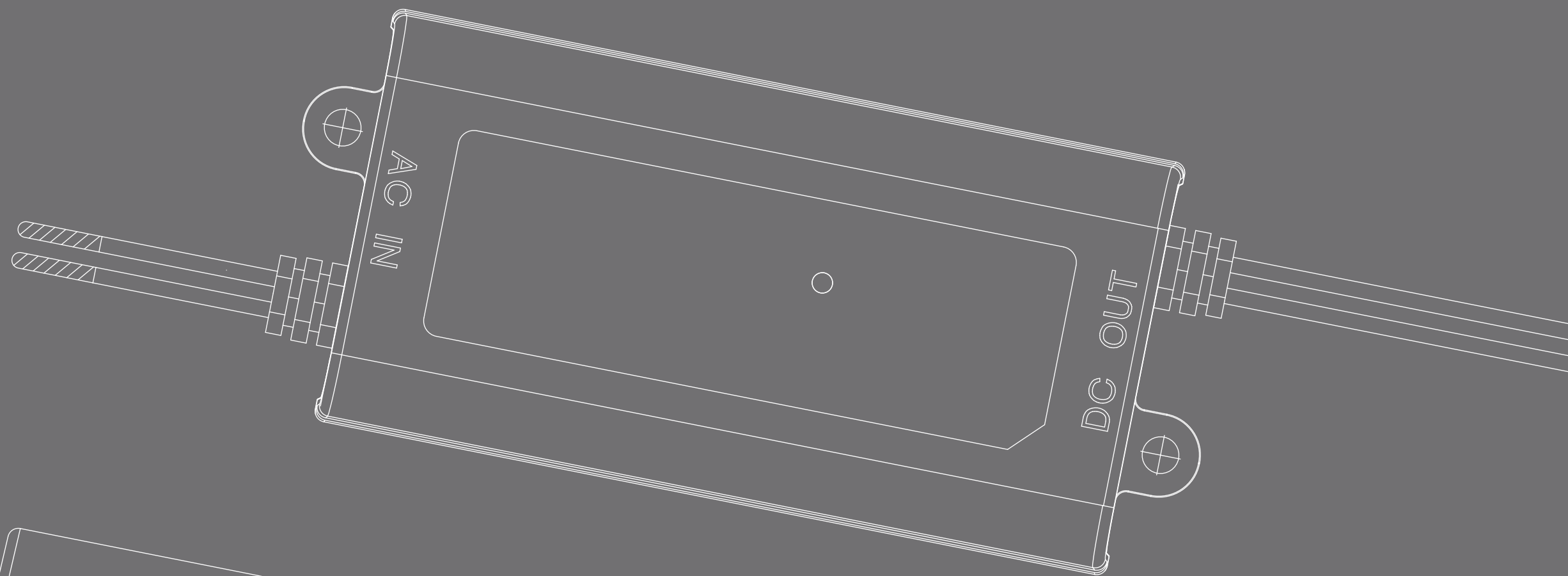

ELECTRICAL INSTALLATION EQUIPMENT

OSPRZĘT ELEKTROINSTALACYJNY / ELEKTROINSTALAČNÍ ZAŘÍZENÍ /
ELEKTROINŠTALAČNÉ ZARIADENIA

PIR

5
years warranty

IP44**



PIR 1



PIR 4



PIR 3

Index	Name	EAN	Pmax [W]	LUX	IP	α	D [m]	L x W x H [mm]	⚖ [kg]
ORO12002	ORO-SENSO-PIR-1 *	5901752719347	200	3-2000	20	120	6	∅ 115 x 55	0,15
ORO12005	ORO-SENSO-PIR-3 **	5901752719378	200	3-2000	44 **	180	12	120 x 80 x 51	0,16
ORO12003	ORO-SENSO-PIR-4 *	5901752719354	200	3-2000	20	120	6	∅ 76 x 75	0,09

MIC

5
years warranty

3*
years warranty



MIC 1



MIC 2



DAYLIGHT

Index	Name	EAN	Pmax [W]	LUX	α	D [m]	L x W x H [mm]	⚖ [kg]
ORO12006	ORO-SENSO-MIC-1	5901752719385	200	3-2000	360	1-8	∅ 95 x 44	0,11
ORO12007	ORO-SENSO-MIC-2	5901752719392	200	3-2000	360	1-8	67 x 39 x 37	0,04
ORO12008	ORO-SENSO-DAYLIGHT-1 *	5902533195992	200	5-50	360		∅ 63 x 77	0,1

POWER SUPPLY



	Index	Name	EAN	P _{max} [W]	AC _{in} [V]	DC _{out} [V]	IP	L x W x H [mm]
	ORO15021	LRS-75-12V-IP20-MW	5901549640861	75	85-264	12	20	99 x 97 x 30
	ORO15022	LRS-100-12V-IP20-MW	5901549640878	100	85-264	12	20	129 x 97 x 30
	ORO15023	LRS-150-12V-IP20-MW	5901549640885	150	85-264	12	20	159 x 97 x 30
	ORO15001	APV-8-12V-IP42-MW	5901752712546	8	90-264	12	42	60 x 30 x 24
	ORO15002	APV-12-12V-IP42-MW	5901549640908	12	90-264	12	42	77 x 40 x 30
	ORO15003	APV-16-12V-IP42-MW	5901752714380	16	90-264	12	42	77 x 40 x 30
	ORO15004	APV-25-12V-IP42-MW	5901549640915	25	90-264	12	42	84 x 57 x 30
	ORO15005	APV-35-12V-IP42-MW	5901549640946	35	90-264	12	42	84 x 57 x 30
	ORO15079	ELG-200-12V-IP65-A-MW	5902533196609	200	90-264	12	65	244 x 71 x 38
	ORO15080	ELG-200-24V-IP65-A-MW	5902533196616	200	90-264	24	65	244 x 71 x 38
	ORO15033	LPH-18-12V-IP67-MW	5902533192946	18	90-264	12	67	140 x 30 x 22
	ORO15067	LPH-18-24V-IP67-MW	5902533194841	18	90-264	24	67	140 x 30 x 22
	ORO15012	LPV-35-12V-IP67-MW	5901549640977	35	90-264	12	67	148 x 40 x 30
	ORO15017	LPV-35-24V-IP67-MW	5901752714243	35	90-264	24	67	148 x 40 x 30
	ORO15013	LPV-60-12V-IP67-MW	5901549640953	60	90-264	12	67	163 x 43 x 32
	ORO15018	LPV-60-24V-IP67-MW	5901752714250	60	90-264	24	67	163 x 43 x 32
	ORO15014	LPV-100-12V-IP67-MW	5901549640984	100	90-264	12	67	190 x 52 x 37
	ORO15019	LPV-100-24V-IP67-MW	5901752714267	100	90-264	24	67	190 x 52 x 37
	ORO15015	LPV-150-12V-IP67-MW	5901549640991	150	90-264	12	67	229 x 52 x 37
	ORO15077	XLG-75-12V-IP67-A-MW	5902533196586	75	100-305	12	67	63 x 140 x 32
	ORO15078	XLG-75-24V-IP67-A-MW	5902533196593	75	100-305	24	67	63 x 140 x 32
	ORO15064	XLG-150-12V-IP67-A-MW	5902533194001	150	100-305	12	67	63 x 180 x 36
	ORO15068	XLG-150-24V-IP67-A-MW	5902533194858	150	100-305	24	67	63 x 180 x 36
	ORO15075	XLG-200-12V-IP67-A-MW	5902533196562	200	100-305	12	67	63 x 200 x 36
	ORO15076	XLG-200-24V-IP67-A-MW	5902533196579	200	100-305	24	67	63 x 200 x 36
	ORO15074	XLG-250-12V-IP67-A-MW	5902533196572	250	100-305	12	67	63 x 250 x 36
	ORO15073	XLG-250-24V-IP67-A-MW	5902533196565	250	100-305	24	67	63 x 250 x 36

EMERGENCY MODULE



Index	Name	EAN	P _{on} [W]	P _{max} [W]	DC _{in} [V]	L x W x H [mm]
ORO15097	EM LED 50W	5902533199938	3	50	max 100	155 x 40 x 30

Li-ion
3,7V

2200
mAh

1
year warranty
BATTERY

IN
220-240V
50Hz

IP67

24 h

1,5 h

60 °C
-20

DRIVER

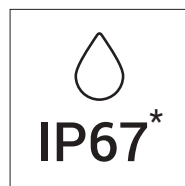

DRIVER

JUNCTION BOX

Index	Name	EAN	P _{max} [W]	DC _{out} [V]	L x W x H [mm]
ORO15081	ORO-DRIVER-12V-12W-IP20	5902533197842	12	12	90 x 40 x 24
ORO15082	ORO-DRIVER-12V-20W-IP20	5902533197859	20	12	120 x 42 x 20
ORO15083	ORO-DRIVER-12V-30W-IP20	5902533197866	30	12	133 x 42 x 30
ORO15084	ORO-DRIVER-12V-40W-IP20	5902533197873	40	12	160 x 58 x 20
ORO15085	ORO-DRIVER-12V-60W-IP20	5902533197880	60	12	185 x 64 x 22
ORO15086	ORO-JUNCTION-BOX-DRIVER-12V-20W-IP67 *	5902533197897	20	12	60 x 60 x 28

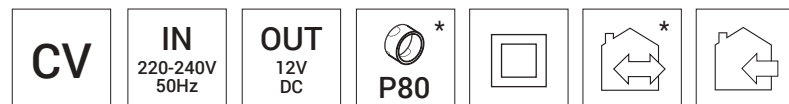

ADAPTER

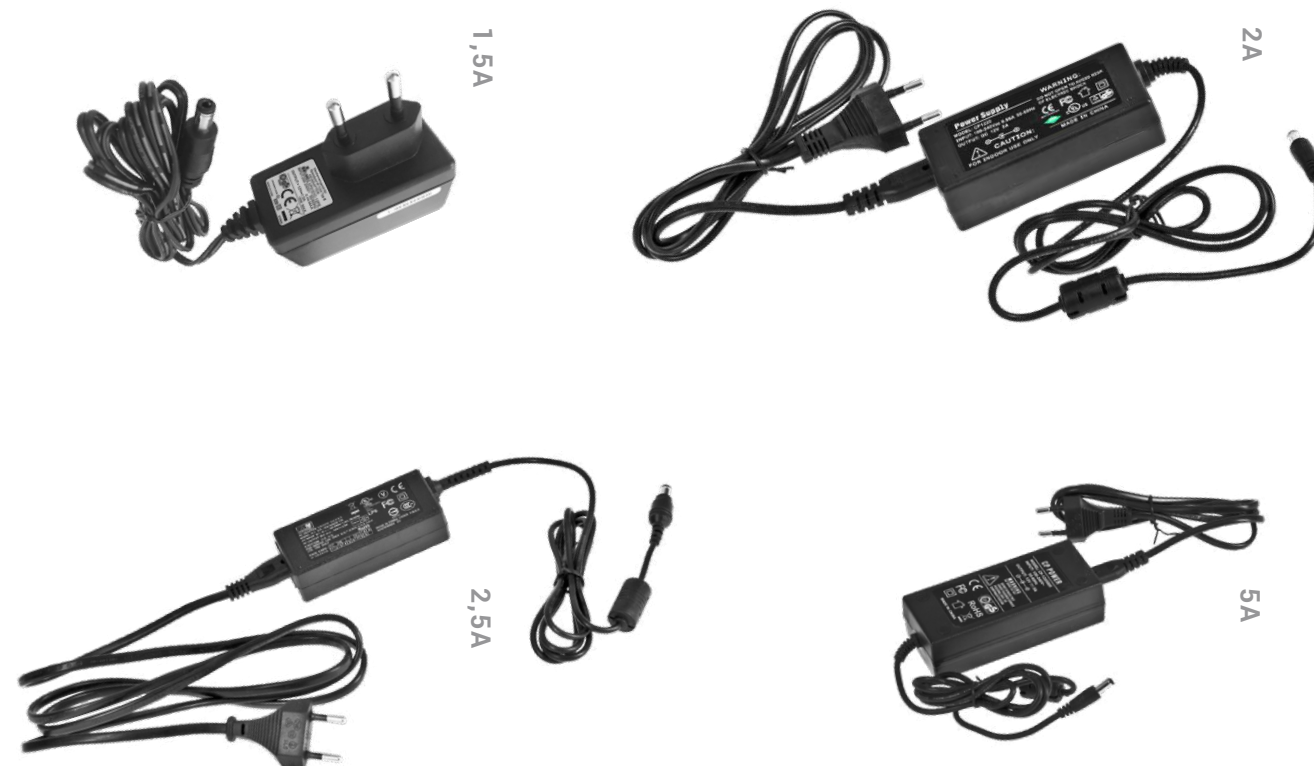

Index	Name	EAN	P _{max} [W]	I _{max} [A]	DC _{out} [V]
ORO15042	ORO-ZASILACZ 1,5A *	5901752716094	18	1,5	12
ORO15043	ORO-ZASILACZ 2A	5901752716100	24	2	12
ORO15045	ORO-ZASILACZ 2,5A	5901752716124	30	2,5	12
ORO15046	ORO-ZASILACZ 5A	5901752716131	60	5	12

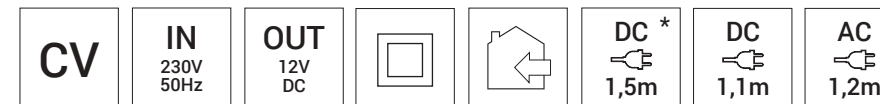



Index	Name	EAN	
ORO14001	ORO-ADAPTER-E14/E27 *	5901752717367	Adapter E14 - E27 / Adapter E14 and E27 / Adaptér E14 - E27 / Adaptér E14 - E27
ORO14002	ORO-ADAPTER-E14/GU10 *	5901752717374	Adapter E14 - GU10 / Adapter E14 and GU10 / Adaptér E14 - GU10 / Adaptér E14 - GU10
ORO14003	ORO-ADAPTER-E27/E14 *	5901752717381	Adapter E27 - E14 / Adapter E27 and E14 / Adaptér E27 - E14 / Adaptér E27 - E14
ORO14005	ORO-ADAPTER-E27/GU10 *	5901752717404	Adapter E27 - GU10 / Adapter E27 and GU10 / Adaptér E27 - GU10 / Adaptér E27 - GU10
ORO14006	ORO-GNIAZDO-GU10 *	5901752717411	Gniazdo GU10 / Socket for GU10 / Patice GU10 / Zásuvka GU10
ORO17022	ORO-STARTER-T8	5902533194551	Starter dla tub LED / Starter for T8 tubes / Startér pro LED trubice / Štartér pre LED trubice



Pon [W], P [W/m]	Moc w trybie włączenia	Power in on mode	Napájení v zapnutém režimu	Napájanie v zapnutom režime
= [W]	Ekwiwalent mocy	Power equivalent	Výkonový ekvivalent	Výkonový ekvivalent
Φ_{mod} [lm]	Strumień modułu	Module flux	Modulový proud	Modulový prúd
Φ_{360° [lm]	Strumień całkowity	Total flux	Celkový tok	Celkový tok
Φ_{use} [lm]	Strumień w kącie	Angle flux	Úhlový tok	Úhlový tok
η [lm/W]	Skuteczność świetlna	Efficacy	Účinnost	Účinnosť
CCT [K]	Temperatura barwowa	Colour temperature	Teplota barev	Teplota farby
L x W x H [mm]	Długość / szerokość / wysokość	Length / width / height	Délka / šířka / výška	Dĺžka / šírka / výška
	Kolor	Colour	Barva	Farba
	Waga	Weight	Hmotnosť	Hmotnosť
	Otwór montażowy	Mounting hole	Montážní otvor	Montážny otvor
EEI	Klasa energetyczna	Energy class	Energetická třída	Energetická trieda
α [°]	Kąt świecenia	Beam angle	Úhel paprsku	Uhol lúča
IP	Klasa szczelności	Ingress protection class	Třída ochrany proti vniknutí	Trieda ochrany proti vniknutiu
DC _{in} [V]	Zasilanie	Power supply	Zdroj napájení	Zdroj
P _{max} [W]	Maksymalne obciążenie	Maximum load	Maximální zatížení	Maximálne zaťaženie
I _{max} [A]	Maksymalny prąd	Maximum current	Maximální proud	Maximálny prúd
	Materiał	Material	Materiál	Materiál
LUX	Czułość dzień/noc	Day/night sensitivity	Citlivost den/noc	Citlivosť deň/noc
AC _{in} [V]	Napięcie zasilania	Supply voltage	Napájecí napětí	Napájacie napätie
DC _{out} [V]	Napięcie wyjściowe	Output voltage	Výstupní napětí	Výstupné napätie

	Material obudowy / klosza	Body and shade material	Materiál krytu / stínidla	Materiál svetidla / tienidla
	Do stosowania wewnątrz / wewnątrz lub na zewnątrz / na zewnątrz	Suitable for indoor / indoor or outdoor / outdoor mounting	Určeno k použití uvnitř / uvnitř nebo venku / venku	Na používanie vo vnútri / vnútri alebo vonku/vonku
	Rodzaje montażu: natynkowy na ścianie / podtynkowy w ścianie / na podłożu / w podłożu / natynkowy na suficie / podtynkowy w suficie / zwieszany / natynkowy na ścianie lub suficie / podtynkowy w ścianie lub suficie	Mounting types: surface-mounted on the wall / flush-mounted in the wall / on the ground / in-ground / surface-mounted on the ceiling / flush-mounted in the ceiling / suspended / surface-mounted on the wall or ceiling / flush-mounted in the wall or ceiling	Typy montáže: na omítku na stěně / pod omítkou ve stěně / na podlaze / v podlaze / na omítku na stropě / pod omítkou ve stropě / závěsná / na omítku na stěně nebo stropě / pod omítkou ve stěně nebo stropě	Druhy montáže: naomietková na stenu / podomietková do steny / na podklade / v poklade / naomietková na strope / podomietková do stropu / závesná / naomietková na stene alebo strope / podomietková do steny alebo stropu
	Możliwość łączenia w linię	Line connection possible	Možnost spojení do řady	Možnosť spájania do radu
	Regulacja jasności	Brightness adjustment	Regulace jasu	Nastavenie jasu
	Zasilacz w zestawie / Brak zasilacza w zestawie	Product includes power supply / Product doesn't include power supply	Napájecí zdroj v balení / Bez napájecího zdroje v balení	Adaptér je súčasťou balenia / Adaptér nie je súčasťou balenia
	Rodzaj przyłącza: przewód z wtyczką / kostka śrubowa / kostka samozaciskowa / wolne końce przewodów	Type of connection: cable with plug / screw cube / self-locking cube / free wire ends	Typ přípojky: kabel se zástrčkou / šroubová svorkovnice / samosvorná svorkovnice / volné konce vodičů	Druh prípojky: kábel so zástrčkou / skrutkovacia kocka / samosvorná kocka / volné konce káblov
	Odległość od oświetlanego obiektu	Distance from the illuminated object	Vzdálenost od osvětleného předmětu	Vzdialenosť od osvetleného objektu
	Możliwość sterowania za pomocą aplikacji	Control via application	Možnost ovládání pomocí aplikace	Možnosť ovládania pomocou aplikácie
	Brak źródła światła w zestawie	Light source not included	Světelný zdroj není součástí dodávky	Svetelný zdroj nie je súčasťou dodávky
	Możliwość montażu na powierzchniach palnych	Possibility of mounting on combustible surfaces	Možnost montáže na hořlavých plochách	Možnosť montáže na horľavých povrchoch
	Pilot w zestawie	Remote control included	Včetně dálkového ovládání	Diaľkové ovládanie súčasťou
	Tryby pracy sterownika	Controller operating modes	Provozní režimy ovládače	Prevádzkový režim ovládača
	Produkt kompatybilny z: E27 / E14 / GU10 / G13	Product compatible with: E27 / E14 / GU10 / G13	Výrobek kompatibilní s: E27 / E14 / GU10 / G13	Výrobok kompatibilný s: E27 / E14 / GU10 / G13
	Klasa ochrony przeciwporażeniowej	Electric shock protection class	Třída ochrany před úrazem elektrickým proudem	Trieda ochrany pred úrazom elektrickým prúdom
	Klasa szczelności IP	IP protection class	Třída ochrany IP	Trieda ochrany IP
	Klasa ochrony mechanicznej	Mechanical protection class	Jedinečný světelný efekt	Jedinečný svetelný efekt

	Temperatura otoczenia	Ambient temperature	Okolní teplota	Teplota okolia
	Trwałość	Rated lifetime	Životnost	Odolnosť
	Kąt rozsyłu	Beam angle	Úhel vyzařování	Uhol vyžarovania
	Napięcie wejściowe	Input voltage	Vstupní napětí	Vstupné napätie
	Współczynnik mocy	Power factor	Faktor síly	Účinník
	Produkt nie jest sprzedawany na polskim rynku	Product is not available on the Polish market	Výrobek není určen k prodeji na polském trhu	Výrobok sa nepredáva na poľskom trhu
	Regulacja kątowna w osi poziomej / w dwóch osiach / w osi pionowej	Angular adjustment in the horizontal axis / in two axes / in the vertical axis	Regulace úhlu ve vodorovné ose / ve dvou osách / ve svislé ose	Uhlové nastavenie v horizontálnej osi / v dvoch osiach / vo vertikálnej osi
	Pole detekcji czujnika	Sensor detection field	Snímané pole čidla	Snímané pole senzoru
	Kąt detekcji czujnika	Sensor detection angle	Snímaný úhel čidla	Snímaný uhol senzoru
	Regulacja czułości czujnika	Sensor sensitivity adjustment	Regulace citlivosti čidla	Nastavenie citlivosti senzoru
	Czas pracy	Working time	Doba provozu	Prevádzková doba
	Regulacja zasięgu detekcji czujnika	Sensor detection range adjustment	Regulace dosahu snímání čidla	Nastavenie dosahu pohybového senzoru
	Wskaźnik oślnienia	Low unified glare rating	Index oslnění	Index oslnenia
	Zmiana temperatury barwowej	Changing the color temperature	Změna barevné teploty	Zmena farebnej teploty
	Klasa energetyczna	Energy class	Energetická třída	Energetická trieda
	Długość cięcia modułu	Module cutting length	Délka řezu modulu	Dĺžka rezu modulu
	Ilość diod LED / m	Number of LEDs / m	Počet LED diod / m	Počet LED diód / m
	Typ akumulatora / pojemność akumulatora / czas ładowania / czas świecenia	Battery type / battery capacity / charging time / lighting time	Typ akumulátoru / kapacita akumulátoru / doba nabíjení / doba svícení	Typ akumulátora / kapacita akumulátora / doba nabíjania / doba svietenia
	Długość przewodu zasilającego	Power cord length	Délka napájecího kabelu	Dĺžka napájacieho kábla
	Unikatowy efekt świetlny	Unique lighting effect	Jedinečný světelný efekt	Jedinečný svetelný efekt

Od 2021 r. każda sprzedana żarówka LED ORO z logo Fundacji "Mysikrólik" wspiera organizację poprzez nasze dotacje. Wybierając te energooszczędne żarówki, przyczyniasz się do ochrony środowiska i zagrożonych gatunków zwierząt.

Since 2021, each ORO LED bulb sold with the "Mysikrólik" Foundation logo supports the organization through our donations. By choosing these energy-efficient bulbs, you contribute to environmental protection and the conservation of endangered animal species.

Od roku 2021 každá prodaná LED žárovka ORO s logem Nadace "Mysikrólik" podporuje organizaci prostřednictvím našich darů. Volbou těchto energeticky účinných žárovek přispíváte k ochraně životního prostředí a zachování ohrožených druhů zvířat.

Od roku 2021 každá predaná LED žiarovka ORO s logom nadácie "Mysikrólik" podporuje organizáciu prostredníctvom našich darov. Kúpou týchto energeticky úsporných žiaroviek prispievate k ochrane životného prostredia a zachovaniu ohrozených druhov zvierat.



BY CHOOSING ORO YOU SAVE ANIMALS



www.led-oro.com



LED manufacturer
since 2006

LED-POL Spółka z o.o. Sp.k.
owner of ORO brand

PL LED-POL Spółka z o.o. Sp.k.
Registered office: 43-300 Bielsko-Biała, 40 Kustronia Street
Address for correspondence: 43-391 Mazańcowice, Mazańcowice 614

SK LED-POL s.r.o. Nitra, Jakuba Haška 3, PSČ 950 47

CZ LED-POL CZ s.r.o. Český Těšín, Karvinská 571/9, PSČ 737 01

www.led-pol.com



ONLINE CATALOG